



Range Plan SS11



Range Plan SS11

Brand Introduction

dunhill is one of the most recognised luxury brands in the world, respected for its quality, consistency and heritage.

The company today is focused on providing superior luxury accessories, designed in an English style, for sophisticated, affluent men all over the world. We believe our focus on English accessories for men clearly differentiates us from the competition while being true to the history of the company.

Indeed, embracing the idea of the new modish British gentleman, Alfred Dunhill has built a distinguished reputation based on the values of style, innovation, quality and wit. Jude's masculine style and unparalleled status as a modern male icon - as well as being a considered and highly accomplished actor - perfectly complements the spirit of dunhill.

dunhill is delighted to introduce the Homes of Alfred Dunhill in London, Shanghai and Tokyo. Committed to advancing the pursuit of male indulgence, this British luxury menswear and accessories brand has developed a unique global concept which embraces the male luxury and retail lifestyle. Reflecting its pillars of masculinity, functionality, quality and Britishness, the Homes of Alfred Dunhill will represent the third dimension of luxury – The Experience, allowing the customer to truly live the brand.

dunhill markets its luxury products through over 200 stores worldwide. Currently there are approx. 2,500 wholesale points of sale globally.

In the 1890s, London was filled with the noise and bustle of the greatest city in the world – horse-drawn carriages, the clatter of horses' hooves and the crack of whips. This was the atmosphere in which Alfred's father, Henry Dunhill, built his flourishing business in the Euston Road from about 1877. Horse leathers, saddlery and accessories for carriages were amongst the items with which the young apprentice, Alfred, at the age of 15, learned his trade. In 1893, Henry Dunhill decided to retire, allowing Alfred, at the age of twenty-one, to take over the business.

Alfred was quick to take up the challenge and soon transformed his father's original business in the horse-carriage trade to that of supplying accessories for the new age of the motor-car. Alfred Dunhill's Motorities soon became integral to the needs of early motor-car drivers.

Alfred was able to supply everything that was required, from heavy, weather-proof leather coats to altitude meters to assist up and downhill motoring, from voltmeters and clocks for the dashboard, to horns of extraordinary shape and musical ability which could frighten off the sleepest drivers of old-fashioned horses and carts.

Alfred opened shops in Mayfair during the 1910s and 20s that set the tone for the growth of the business. Alfred supplied not only the technical extras but also elegant motoring attire for ladies and gentlemen.

He also catered for his customers' social aspirations with such wonderful products as luncheon and tea outfits for what would become a celebrated English pastime – a picnic in the country, whatever the weather!

The move into true luxury goods goes back to the 1920s. An office in New York was opened on 5th. Avenue in 1921, and in London a further shop was established in 1923. By the mid 1930s, dunhill was considered one of the most 'luxuriously appointed luxury emporiums for men'. Goods included stationery, playing cards, frames, diaries, cocktail sets and bar accessories. By the late 1970s, dunhill was offering a range of 3500 luxury products for men in over 20 countries including a ready to wear collection launched in 1976.

Royalty, rulers, Indian princes, politicians, diplomats, stars of stage & screen from Europe and the USA and celebrities of every description passed through the shop.

Patrons included Pablo Picasso, Winston Churchill, The prince of Wales, Elvis Presley, Frank Sinatra, and many others.

- 1893 – Alfred Dunhill takes over his father’s saddlery business*
- 1903 – 1st Watch, dashboard clock*
- 1904 – Alfred Dunhill’s Motorities opened on the Euston Road*
- 1907 – Jermyn Street shop opened*
- 1910 – Introduction of Writing Instruments*
- 1921 – Shop opened in New York*
- 1924 – Shop opened at 15 Rue De La Paix, Unique lighter introduced*
- 1935 – Duke St, St James shop extension commenced, once completed this would allow the business to carry its wider range of products under one roof*
- 1936 - Gentleman’s Wrist & Pocket watches launched*
- 1953 – 1st Sports Watches*
- 1956 – Rollagas lighter launched*
- 1976 – 1st Full menswear collection*
- 1993 – Alfred Dunhill celebrates its centenary*
- 1997 – 123 Retail outlets exist in 24 countries around the world*
- 2003 – 15 rue de la Paix shop re-opened*
- 2005 – Flagship store opened in Moscow*
- 2006 – Joint venture agreement in China giving dunhill direct control of 24 retail stores*
- 2007 – Alfred Dunhill Home opened in Tokyo*
- 2008 – Alfred Dunhill Home opened in Shanghai and in London*
- 2010 - Alfred Dunhill Home opened in Hong Kong*



Range Plan SS11

Cufflinks

dunhill has been making highly distinctive and individual cufflinks for men since the 1930s. These cufflinks are worn by a discerning man who understands that in terms of Englishness, and of luxury, dunhill does it better than anyone else. dunhill continuously provides customers with designs that communicate personality, and that set dunhill apart from the competition. From the initial design drawings through to the final execution of the finished product, each dunhill cufflink has a confidence and quality that few can match.

Using sterling silver, 18ct gold and steel as base materials, sourced internationally from superior suppliers, each cufflink is rhodium plated to avoid tarnishing. It is then individually hand polished by skilled craftsmen, ensuring the highest level of finish.

Each season, the cufflink collection is rigorously analysed and creatively developed to ensure a balance between time-proven classics and pieces with newness and originality.

With the highly original curved finding, a dunhill cufflink displays a quiet elegance on the inside of the cuff as well as the outside.

SS11



JHL0212K
Helm wheel cufflinks
Stainless steel & Teak wood

SS11



JLL0219K
Facet rubber stripe cufflink
Stainless steel & rubber

SS11



JLL0220K
Double AD coin cufflink
Stainless steel & rubber

SS11



JLL0221K
Deckchair cufflink
Stainless steel

SS11



JLL0222K
Ferris wheel cufflink
Stainless steel

SS11



JLL0223K
Sentryman logo cufflink
Stainless steel & PVD

SS11



JLL0226K
Screw top cufflink
Stainless steel & MOP

SS11



JLL8292H
Facet square pinstripe red cufflink
Sterling silver, white mother of pearl & red cornelian

SS11



JLL8293H
Facet square pinstripe blue cufflink
Sterling silver, white mother of pearl & sodalite

SS11



JML8289H
Crab cufflink
Sterling silver & rhodium plated

SS11



JTL5211K
AD vintage logo cufflink
Brass & polished pink gold plated

SS11



JTL3210K
Double-sided travel cufflink
Brass platinum plate & blue mother of pearl



JXK8227H
Submarine Window
cufflink
Sterling silver &
hematite



JXK8228H
Airship
cufflink
Sterling
silver



JLK0203K
'AD' Vintage
suspension coil
cufflink
Platinum plated



JXK3200K
Wing cufflink
Platinum plated
& brass



JHK0207K
'AD' Facet cufflink
Gold plated



JHK0206K
'AD' Facet cufflink
Platinum plated



JLK0202K
Torch cufflink
Blue lacquer
& steel



JLK0201K
Torch cufflink
Pink lacquer &
steel



JMK8202H
Rabbit
cufflink
Sterling
silver



JSK8260H
Samurai Sword
cufflink
Sterling silver



JSK8261H
Facet cufflink
Sterling silver & white
mother of pearl



JSH8280H
Tiger cufflink
Sterling silver



JCG8244H
Horse
cufflink
Sterling
silver



JSJ8208H
Elephant cufflink
Sterling silver



JSJ8204H
Shark
S/S



JSG3213K
Spinning Globe
cufflink
Platinum plated



JTJ8214H
Anchor
cufflink
Sterling silver



JSG8205H
Studs
Sterling silver, onyx &
carbon fibre



JNG0233K
Rotating Buckle
Carbon fibre, stainless
steel



JSH0258K
Switch cufflink
Onyx & stainless steel



JSD0257K
Switch cufflink
Blue mother of pearl &
stainless steel



JFG3211K
Compressor
Platinum plated,
black lacquer



JSD3268K
Eight
Platinum plated



JTJ0227K
'AD' Vintage Logo
Platinum plated



JVT8210H
Bulldog cufflink
Sterling silver



JSY8266H
Steering Wheel
cufflink
Sterling silver



JSE8228H
Gear Stick
cufflink
Sterling silver &
black resin



JSJ0202K
Hatch Wheel cufflink
Ruthenium plate & hematite



JSF8264H
Steering Wheel
cufflink
Sterling silver & briar
wood



JSD0273K
Alfred Dunhill Coin
cufflink
Carbon fibre &
stainless steel



JSB8201H
Alfred Dunhill Coin
cufflink
Sterling silver & onyx



JSB8202H
Alfred Dunhill Coin
cufflink
Sterling silver & sodalite



JSE3200K
Alfred Dunhill Coin
cufflink
Diamond pattern
ruthenium plate



JNH0240K
Piston cufflink
Stainless steel



JSE5203K
Alfred Dunhill Coin
cufflink
Gold plate & white
mother of pearl



JSG3214K
Sentryman Cap
cufflink
Blue sodalite &
platinum plated



JSH0216K
Sentryman Cap
Engine turned pattern
cufflink
Platinum plated



JSH8290H
Facet Square cufflink
Sterling silver & galaxy stone



JSH8291H
Facet Square cufflink
Sterling silver & blue sodalite



JSJ8292H
Facet square pinstripe cufflink
Sterling silver, onyx & white mother of pearl



JHJ0243K
Engine turning lines
Platinum plated



JHJ5244K
Engine turning lines
Gold plated



JSF3203K
Faceted Diamond Pattern cufflink
Platinum plated



JSH0257K
'D' Buckle cufflink
Dark grey shagreen & black PVD



JSH0245K
'D' Buckle cufflink
brushed finish
Platinum plated



JXJ8230H
Submarine window cufflink
Sterling silver & galaxy stone



JBF6200H
Four Leaf Clover cufflink
Sterling silver & black mother of pearl



JCE8236H
Four Leaf Clover cufflink
Sterling silver



JBH4224H
Four Leaf Clover
Pink Gold



JSJ0217K
Sentryman Cap cufflink
Meteorite, Brass, PVD, Black Diamond Lacquer



JBF6201H
Bull Dog cufflink
Onyx & sterling silver



JFF8218H
Night & Day cufflink
Sterling silver & blue Mother of pearl



JSV8235H
Alfred Dunhill Classic Button cufflink
Sterling silver & white mother of pearl



JSY8267H
Alfred Dunhill Classic Button cufflink
Sterling silver & pink mother of pearl



JSB8203H
Alfred Dunhill Coin cufflink
Sterling silver & white mother of pearl



JSA8206H
Classic Button Diamond cufflink
Sterling silver, diamond & rhodium plate



JSD8279H
Tile diamond cufflink
Sterling silver



JSH8299H
Cylinder With Sapphires
Sterling silver, Sapphires & rhodium plated



JBK4274H

London lantern

London Lantern Cufflinks

Material : 18ct pink gold, 1.44ct Diamonds W/SI

Finish : Polished

Branding : Alfred Dunhill on back of finding

Exclusively designed for Alfred Dunhill, these cufflinks were inspired by the traditional City of London lanterns. The most precious cufflinks in the AW10 collection, they are linked to a traditional shape, but with a modern, faceted finish. The precious 18ct pink gold of the lantern cufflink warms up the winter, while the diamonds light it up.

The London Lantern is available in a lacquer box with a Limited Edition certificate.

Limited Edition number: 1 of 25. The Limited Edition number is placed on the forepart, between the 'Alfred Dunhill' branding.



JBG6202H
Jade Stone Turtle

Jade Stone Turtle Cufflinks

Material : Sterling Silver, Jade

Finish : Polished

Branding : Alfred Dunhill on finding

Hand cut masterpiece, beautifully crafted by a stone specialist.

Symbol of good fortune and longevity around the world.

Limited Edition number: 1 of 150. The Limited Edition number is placed on the side of the finding arm.

The Jade Stone Turtle is available in a lacquer box with a Limited Edition certificate.



JSF3202K
Flying Scotsman

Flying Scotsman Cufflinks

Material : Bronze, Lacquer, Platinum Plated.

Finish : Polished

Branding : Alfred Dunhill on finding

Includes material from the fire box from the Flying Scotsman train, often referred to as "the most famous steam locomotive in the world". It was built in 1923 for the London and North Eastern Railway (LNER) at Doncaster Works to a design of Sir Nigel Gresley. It was employed on express trains on the East coast Main Line from London King's Cross to Doncaster, Leeds, York, Newcastle-upon-Tyne or Edinburgh. It was commonly employed on the Flying Scotsman service, its namesake, from London to Edinburgh.

Launch of products to coincide with the re-launch of the locomotive after restoration work.

Limited Edition number: 1 of 250. The Limited Edition number is placed on the side of the finding arm.

The Flying Scotsman is available in a lacquer box with a Limited Edition certificate.

Cufflinks – Limited Edition

JRG7234K
Fighter Provenance

Fighter Provenance Cufflinks

Material : Aluminium

Finish : Polished

Branding : Alfred Dunhill on finding

These cufflinks are impressively crafted using the original aluminium engine casing taken from the Rolls Royce Merlin engine of the WW2 Spitfire MK1 X4276 KL-B. The serial no is included on the underside of the cufflink. This particular jet was the personal choice of the legendary WW2 ace Alan C Deere who, by the end of the conflict, had heroically shot down 22 enemy aircrafts, with another 10 “probable”. Spitfire was the finest fighter of its day, a true and celebrated feat of great design and zeal.

Limited Edition number: 1 of 150. The Limited Edition number is placed on the side of the finding arm.

The Fighter Provenance is available in a lacquer box with a Limited Edition certificate and a Provenance leaflet.



JBG8285H
Sentryman Black Diamonds

Sentryman Black Diamonds Cufflinks

Material : Sterling Silver, 70 black diamonds, 0.05ct per pair

Finish : Polished

Branding : Alfred Dunhill on finding

Apex addition to the successful Sentryman collection

Limited Edition number: 1 of 150. The Limited Edition number is placed on the side of the finding arm.

The Sentryman Black Diamond is available in a lacquer box with a Limited Edition certificate and a diamond certificate.



JSE8276H
AD Coin with White Diamonds

AD Coin with White Diamonds Cufflinks

Material : Sterling Silver, 72 white diamonds quality SI, 1.08 ct per pair.

Finish : Polished

Branding : dunhill longtail on finding

Ideal for evening wear

Apex addition to the successful AD Coin family.

Limited Edition number: 1 of 250. The Limited Edition number is placed on the side of the finding arm.

The AD Coin with White Diamonds is available in a lacquer box with a Limited Edition certificate.



JSG3210K
Sentryman Cap Black Tie

Sentryman Cap Black Tie Cufflinks

Material : brass, black PVD, white mother of pearl

Finish : Polished

Branding : Alfred Dunhill on back of finding

Exclusively designed for Alfred Dunhill, inspiration comes from “Black Tie” evening wear.

Fluted edges are similar to the Sentryman pen cap. Has a winding mechanism similar to the crown of a watch.

Limited Edition number: 1 of 150. The Limited Edition number is placed on the side of the finding arm.

The Sentryman Cap Black Tie is available in a lacquer box with a Limited Edition certificate.



JSF8265H
Steering Wheel with Diamonds

Steering Wheel with Diamonds Cufflinks

Material : Sterling Silver, white diamonds, black diamonds, ruthenium setting, white diamonds are all quality VVSI., 0.52ct in total per pair.

Finish : Polished

Branding : d logo in the middle of the cufflink. Alfred Dunhill on finding

The black diamonds used in the product are of a natural origin and have been permanently treated, to achieve a consistent coloration. They do not require special care.

Apex addition to the successful steering wheel family.

Limited Edition number: 1 of 100. The Limited Edition number is placed on the side of the finding arm.

The Steering Wheel with diamonds is available in a lacquer box with a Limited Edition certificate.



JSF8258H
Gherkin design with Diamonds

Gherkin design with Diamonds Cufflinks

Material : Sterling Silver, black and white enamel, 64 white diamonds, 032ct per pair, quality VVSI.

Finish : Polished

Branding : Alfred Dunhill on finding

Design inspired by iconic British architecture. The “Gherkin” as it is nicknamed is one of the city of London’s most ingenious and elegant buildings, it’s official name is 30 St Mary Axe.

Beautifully crafted translucent and opaque enamels.

Limited Edition number: 1 of 100. The Limited Edition number is placed on the side of the finding arm.

The Gherkin with Diamonds is available in a lacquer box with a Limited Edition certificate.



Range Plan SS11

Accessories

Since the very earliest days of the brand, men's jewellery accessories have always provided the dunhill customer with the opportunity to display elegance and individuality.

This tradition continues with each new season, where classic dunhill signature designs, such as the Bulldog and the Motorities Steering Wheel, are re-interpreted across a range of pieces. These have proven to be strong gifting items.

SS11



JLL0807K

Facet Rubber Stripe Keyfob

SS11



JNL3827K

Sentryman Screw Keyfob

SS11



JLL0709K

Facet Rubber Stripe Mobile
Phone Tag

SS11



JLL0710K

Double AD Coin Mobile
Phone Tag

SS11



JML8799H

Keyfob Crab S/S

SS11



JML8799H

Mobile Phone Tag Crab



JLK0804K
Key Fob 'AD' Vintage
Suspension Coil PDP



JMK8803H
Key Fob Rabbit S/S



JCG8844H
Key Fob Racing Horse S/S



JSH8881H
Key Fob Tiger S/S



JSH8835H
Key Fob Decision Coin S/S



JPG0803K
USB Key Fob
2GB USB Carbon Fibre, Stainless Steel



JPD0812K
USB Key Fob
Bulldog 2GB USB Stainless Steel



JSF8804H
Key Fob Steering Wheel
S/S, Briar Wood



JNG0833K
Key Fob Rotating Buckle
Carbon fibre, Stainless Steel



JDV8803H
Key Fob Bulldog S/S

SS11



JLL0612K

Money Clip Facet Rubber Stripe

SS11



JLL0611K

Money Clip Deckchair



JTJ0631K

Money Clip AD Vintage Logo
Platinum Plated



JFE3650K

Money Clip Carbon Fibre
Platinum Plated, Brushed
Finish



JFE8632H

Money Clip Diamond Pattern S/S



JTH0619K

Money Clip Tiger Pattern
Platinum Plated, Brushed Finish



JFW8607H

Money Clip Bulldog S/S,
Rhodium Plated



JBZ8609H

Money Clip Steering Wheel S/S

SS11



JLL0124K

Facet Rubber Stripe Tiebar

SS11



JLL0124K

Facet Rubber Stripe Tiebar



JHK0109K

AD Facet GP Tiebar



JHK0108K

Facet PP Tiebar



JFG3111K

Tiebar Compressor Platinum plated



JSF3102K

Tiebar Faceted Diamond
Pattern Platinum plated



JTJ0128K

Tiebar AD Vintage Logo PP



JSB8101H

Tiebar Alfred Dunhill Coin S/S Onyx



JK8700H

Collar Stiffeners Pair, UK Hallmark S/S



Range Plan SS11

Lighters

Lighters have played an important part in dunhill's history. In 1924, Alfred Dunhill invented the first lighter that could be operated with one hand – the Unique (the very first prototype of this lighter was made using a Coleman's Mustard tin as the base!). Since then, dunhill has continuously innovated and delivered the very best in lighters. Elvis Presley and Pablo Picasso are counted amongst those who used a dunhill lighter. Today's dunhill range of lighters continues this tradition of excellence, with objectives that have not changed since the earliest days. dunhill is committed to delivering lighters that work first time every time - combined with innovative design touches that set them apart.

SS11



QLL2214
Turbo Carbon Fibre
Rubber

SS11



QLL2216
Turbo Teak

SS11



RLL1313
Rollagas AD Vintage
Logo Palladium

SS11



RLL2510
Rollagas Satin
Ruthenium

Rollagas



PLF6210

Hobnail 18CT
Yellow Gold



RLJ2553

Rollagas Soft
Lacquer Rup



RLK1504

Rollagas Texalium



RLJ3305

Briar Wood
Palladium Plated



RLH1375

Tiger Pattern
Palladium Plated



RLG2323

Diamond Pattern
Blue Tinted Lacquer,
Palladium Plated



RLG3325

Diamond Pattern
Black Resin, Palladium
Plated



RLD3302

Carbon Fibre Pattern
Palladium Plated



RLZ3300N

Sidecar Leather
Cowhide, Palladium
Plated

Rollagas



RLZ2311N
Black Lacquer
Palladium Plated



RL2401N
Black Lacquer Gold
Gold Plated



RL2491N
Gemline
Charcoal Pinstripe
Lacquer, Gold Plated



RL8400N
Signature
Gold plated



RL1301N
Barley
Engine Turning Pattern,
Silver Plated



RLK1500
Sentryman Groove
Ruthenium, Palladium
Plated

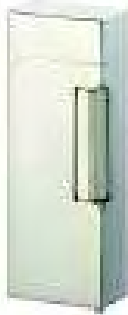

PL6200
Rollagas 18CT
White Gold Facet



PL9200
Mini Rollagas
18CT Facet Roller

Unique Sports Turbo



QLK2300
Shagreen
PVD



QLF2001
Diamond Pattern
Silver Plated, Rhodium Plated



QLA2603
Matt Black Alligator
Silver Plated, Rhodium Plated



QLV2614
Sidecar Leather
Cowhide, Silver Plated, Rhodium Plated



QL2000
Silver
Silver Plated, Rhodium Plated

Unique Pocket



UL1301
Barley
Engine Turning Pattern,
Silver Plated



UL1302
Vertical Lines
Silver Plated

Accessories for Lighters & Operating Instructions

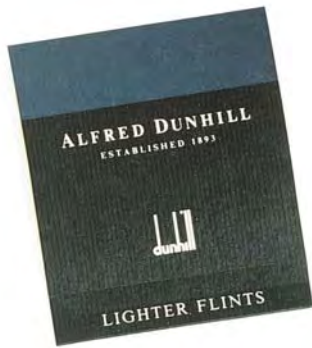

LA1101
Blue (Unique) Flints
9 PCS per wallet

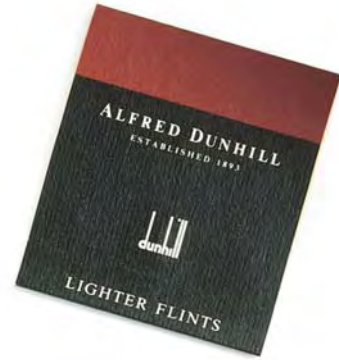

LA1201
Red (Rollagas) Flints
9 PCS per wallet



LA2103
Butane Gas refill
(90 ml) Outside UK
LA2108
Butane Gas refill
(25ml) For UK only



LA4000
Petrol Lighter Fuel
(125 ml) All markets

Accessories for Lighters & Operating Instructions

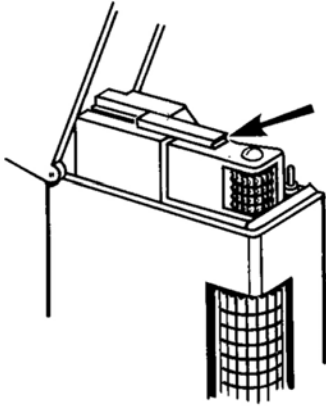

The Rollagas Flint (Red)

The flint slide continually adjusts as the flint wears thus giving a constant visual reference. The flint chamber springs open when the slide is pressed back and the new flint is inserted in seconds.

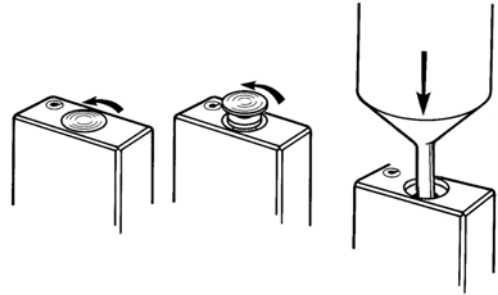

The Filling Procedure

Fit the white adaptor to the dunhill butane gas refill (adaptor enclosed in cap of refill.) Twist the back cap till it pops open, then pull it out. Place the lighter upside down on a rigid surface. The refill inserts vertically into the valve at the base of the lighter. This valve is specially designed to prevent the lighter from being overfilled when the correct procedure is followed.

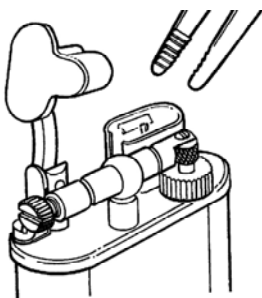

The Unique Pocket/ Sports/ Table flint (Blue)

A Horizontal fitted spring and screw enable the flint to be quickly changed by their removal. The remains of the old flint are then shaken out, the new flint inserted, and the spring adjusted to produce a spark.

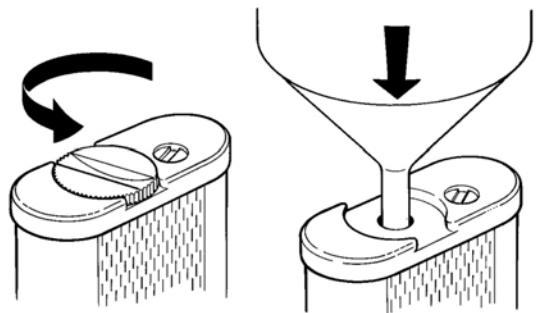

The Filling Procedure

The dunhill butane gas refill inserts into a valve in the base of the lighter that is revealed when the large centre screw is removed. This valve is specially designed to prevent the lighter from being overfilled when the correct procedure is followed.

NB (white adaptor should not be used for unique range).



Range Plan SS11

Writing Instruments

Committed to the art of writing, dunhill continually innovates and surprises in its execution of such a seemingly simple accessory as the pen. Few other brands have the history, and the legitimacy of dunhill when it comes to writing instruments. Since 1910, dunhill products underpin this, with beautifully designed items made using only the finest materials. Together, the products form a comprehensive and commercial overall collection.

The Plated pens are made from solid brass ensuring strength, while the Lacquered pens use the latest technology to provide the best available products.

Nibs

The nibs are made from 18ct Gold and are handcrafted in a traditional way which gives smoothness, flexibility and exceptionally reliable ink flow. Iridium tipped nibs give consistently smooth, skip free writing.

Pens with gold plating have 18ct yellow gold nib tips. Pens with polished, brushed or silver Finish have 18ct yellow gold and rhodium Plated nibs. All nibs are interchangeable to cater for all sizes of writing. Both cartridges and converters are available.

Sidecar Writing Instruments



NUE1633
Sidecar FP Victorian PDP Lacquer



NUC2423 Ballpoint
NUC1423 Fountain Pen
Sidecar Matt Brown Alligator Chassis



NUJ2253
Sidecar Revolette Skeleton

Sidecar Locomotive



NUK2023
Ballpoint
PVD, Ruthenium
Plated



NUK3023
Rollerball
PVD, Ruthenium
Plated

Sidecar Briar



NUJ2213
Ballpoint
Briar wood,
Palladium Plated



NUJ3213
Rollerball
Briar wood, Palladium Plated

Sidecar Black Resin



NUW1113
Fountain Pen
Palladium Plated



NUW2113
Ballpoint
Palladium Plated



NUW3113
Rollerball
Palladium Plated



NUW4110
Pencil
Palladium Plated

Sidecar Chassis Black Resin



NUA2203
Ballpoint
Palladium Plated



NUA3203
Rollerball
Palladium Plated

Sidecar Black Resin with Gold Attributes



NUA1233
Fountain Pen
Gold Plated, bi-colour
18ct gold nib



NUA2233
Ballpoint
Gold Plated



NUA3233
Rollerball
Gold Plated



NUA4230
Pencil
Gold Plated

Sidecar Chassis Black Resin with Gold Attributes



NUD2463
Ballpoint
Gold Plated



NUD3463
Rollerball
Gold Plated

Sidecar Revolette



NUB2303

Black / Red Ballpoint / Pencil
Black Lacquer, Palladium
Plated



NUE2653

Black / Red Ballpoint / Pencil
Diamond pattern engine turned,
Palladium Plated

Sidecar Streamliner Writing Instruments

Sidecar Streamliner Black Lacquer



NUG1783
Fountain Pen
Black Lacquer, Palladium
Plated



NUG3783
Rollerball
Black Lacquer, Palladium
Plated



NUF2783
Ballpoint
Black Lacquer,
Palladium Plated

Sidecar Streamliner Black Lacquer with Gold Attributes



NUG1793
Fountain Pen
Black Lacquer, gold Plated



NUG3793
Rollerball
Black Lacquer, gold Plated



NUF2793
Ballpoint
Black Lacquer, gold Plated

Sidecar Streamliner Writing Instruments

Sidecar Streamliner Black Pearl



NUG1823
Fountain Pen
Black nickel Finish,
Palladium Plated



NUG3823
Rollerball
Black nickel Finish, Palladium
Plated



NUF2823
Ballpoint
Black nickel Finish,
Palladium Plated

Sidecar Streamliner Brushed Stainless Steel



NUJ3323
Rollerball
Brushed Finish, Palladium Plated



NUJ2323
Ballpoint
Brushed Finish,
Palladium Plated

Sidecar Streamliner Writing Instruments

Sidecar Streamliner Chassis



NUH1273
Fountain Pen
Black Lacquer, Palladium Plated



NUH2273
Ballpoint
Black Lacquer, Palladium Plated



NUH3273
Rollerball
Black Lacquer, Palladium Plated

Sentryman



NWL3103
Satin Ruthenium RB



NWH1263
FP Grey Shagreen PV



NWH2523
BP Carbon Fibre PDP



NWF1963
FP Black Diamonds
Fabric



NWE1533
FP Black Alligator PDP



NWE2533
BP Black Alligator
Chassis



NWL2063
Revolette



NWL2103
Satin Ruthenium BP

Sentryman USB



NWK2043

Ballpoint with USB,

Black PVD, Red Aluminum, Red Resin

Sentryman Soft Lacquer



NWJ2343

Ballpoint
Ruthenium, Lacquer

NWJ3343

Rollerball
Ruthenium Plated, Lacquer

Sentryman Black Resin



NWD1503
Fountain Pen
Palladium Plated



NWD2503
Ballpoint
Palladium Plated



NWD3503
Rollerball
Palladium Plated



NWD4500
Pencil
Palladium Plated

Sentryman Black Resin with Gold Attributes



NWD1553
Fountain Pen
Gold Plated



NWD2553
Ballpoint
Gold Plated



NWD3553
Rollerball
Gold Plated



NWD4550
Pencil
Gold Plated

Sentryman Diamond Pattern



NWD3513
Rollerball
Diamond engine turning,
Palladium Plated



NWD2513
Ballpoint
Diamond engine turning,
Palladium Plated



NWG2983
Ballpoint
Diamond cut resin,
Palladium Plated



NWG3983
Rollerball
Diamond cut resin,
Palladium Plated

Sentryman Carbon Fibre



NWD1523
Fountain Pen
Palladium Plated



NWH2523
Ballpoint
Palladium Plated



NWD3523
Rollerball
Palladium Plated

Writing Instruments - Limited Editions

Each of the following Limited Edition products is numbered and presented in the Alfred Dunhill Lacquer box with its Limited Edition certificate.

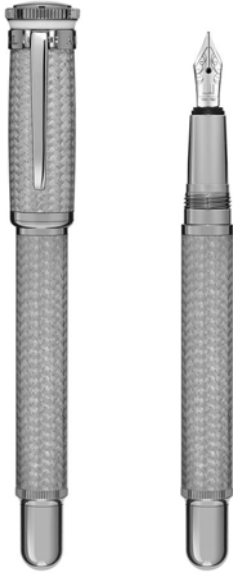
Sentryman Explorer II

NWK1093

Fountain Pen/Ballpoint/Pencil

Sentryman Explorer II

Material : Brass / carbon fibre PVD coating / ruthenium with 18ct gold and rhodium nib

Finish : Polished barrel and cap with polished attributes / Carbon fibre coating

Branding : Vintage AD logo

The Sentryman Explorer II contains a torch in the barrel which can be used just by pulling the tip of the barrel off. Finished with a patent pending PVD coated carbon fibre process, the pen also features a luminous cap ring and interchangeable fountain pen, ballpoint and pencil foreparts. The fountain pen nib is 18ct gold with rhodium plating.

The Sentryman Explorer II is available in a Lacquer box with a Limited Edition certificate.

Limited Edition number: 1 of 150. The Limited Edition number is placed on the logo button ring on the top of the cap.

Writing Instruments - Limited Editions

Each of the following Limited Edition products is numbered and presented in the Alfred Dunhill Lacquer box with its Limited Edition certificate.

Sentryman Black Tie

NWG3353

Rollerball

Sentryman Black Tie

Material : Brass/ black PVD coating/ Mother of pearl button

Finish : Polished black PVD coating

Branding: Alfred Dunhill on the clip ring

The Sentryman Black Tie epitomises dunhill's commitment to style with substance, characterizing the ultimate sophistication in formal dressing. The polished black PVD Finish - which is as resilient as it is polished - gives the piece a strong masculine appeal.

This piece of epistolary elegance is capped with a white mother of pearl button.

The Sentryman Black Tie is available in a Lacquer box with a Limited Edition certificate.

Limited Edition number: 1 of 888.

Sentryman Meteorite

NWJ2333
Ballpoint



NWJ3333
Rollerball

Sentryman Meteorite

Material: Lacquer / Brass / PVD

Finish: Polished barrel and cap with polished attributes

Branding: Vintage AD logo cap button

This addition to the popular Sentryman range features an innovative Finish: authentic meteorite stone and black diamonds are crushed in the Lacquer for a stunning effect, giving the Sentryman Meteorite a precious and unique twist. It also features a unique clip with a fantastic spring effect. The black PVD Finish matches the Lacquer perfectly and gives the piece a strong masculine appeal.

The Sentryman Meteorite is available in a Lacquer box with a Limited Edition certificate, as well as a leaflet explaining the material process.

Limited Edition number: 1 of 888. The Limited Edition number is placed on the forepart, between the 'Alfred Dunhill' branding.

Sentryman Flying Scotsman



NWF1733

FP Flying Scotsman

Material : Lacquered bronze provenance material / Palladium plate

Cap Button : Red lacquered ring / Lacquered bronze provenance material

Finish : Polished barrel and cap with polished attributes

Branding : D logo cap button

A new addition to the dunhill British themed limited edition collection.

Includes material from the fire box from the original Flying Scotsman train, often referred to as “the most famous steam locomotive in the world”. It was built in 1923 for the London and North Eastern Railway (LNER) at Doncaster works to a design of Sir Nigel Gresley.

Launch of products to coincide with the re-launch of the locomotive after restoration work.

The fountain pen nib is 18ct gold with a rhodium plating.

Limited Edition number: 1 of 250. Limited Edition number round bottom of the cap.

Lacquered Alfred Dunhill box with limited edition certificate.

Sentryman Explorer



NWH1013

FP Explorer

Material : brass, anodized aluminium, palladium plated

Finish : Polished barrel and cap with polished attributes

Branding : d logo cap button

Exclusively designed for Alfred Dunhill, inspiration comes from South Pole explores.

Sentryman Explorer has an artificial flint in the barrel that can be used by striking against the cap top. It also features a luminous cap ring and inter changeable fountain and ball point foreparts.

Will be sold with a matching pen tube with carabina (clip).

Limited Edition number: 1 of 150. The Limited Edition number is on the logo button ring on the top of the cap.

The fountain pen nib is 18ct gold with a rhodium plating.

Lacquered Alfred Dunhill box with Limited Edition certificate.



MVWR505A

Black Ink

MVWR506N

Blue Ink



MVNW0004

Sentryman Converter x 1

MVNZ6401

Sidecar Converter x 1



MVWR6101

Black Ink Cartridges x 10

MVWR6102

Blue Ink Cartridges x 10



MVNW4880

Sentryman 0.7 mm Leads x 12 and Erasers x 3

MVNY4885

Sidecar 0.7 mm Leads x 12 and Erasers x 3

MVNU4885

Sidecar Mini 0.7 mm Leads x 12 and Erasers x 3

MVNV4880

Revolette 0.7 mm Pencil Refills x 12

Sentryman / Sidecar / Streamliner



MVNY6301

Black Ballpoint Refill
Fine x 1

MVNY6501

Black Ballpoint Refill
Medium x 1



MVNY6801

Blue Ballpoint Refill
Fine x 1

MVNY6302

Blue Ballpoint Refill
Medium x 1

Sidecar Mini

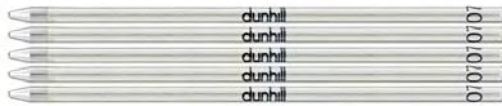

MVNV6305

Black Ballpoint Refill
Medium x 5



MVNV6306

Blue Ballpoint Refill
Medium x 5

Revolette



MVNV6350

Black Ballpoint Refill
Medium x 5



MVNV6351

Red Ballpoint Refill
Medium x 5

Sentryman



MVNW0046

Black Rollerball Refill
Medium x 1

MVNW0058

Blue Rollerball Refill
Medium x 1

Sidecar

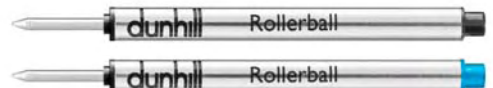

MVNY6601

Black Rollerball Refill
Medium x 1

MVNY6602

Blue Rollerball Refill
Medium x 1

Sentryman / Sidecar

MVNW1001
18ct yellow gold
Extra Fine

MVNW1002
18ct yellow gold
Fine

MVNW1003
18ct yellow gold
Medium

MVNW1004
18ct yellow gold
Broad



MVNW1021
18ct, rhodium plated
Extra Fine

MVNW1022
18ct, rhodium plated nib
Fine

MVNW1023
18ct, rhodium plated
Medium

MVNW1024
18ct, rhodium plated
Broad

Sidecar Mini

MVNU0021
18ct, rhodium plated
Extra Fine

MVNU0022
18ct, rhodium plated
Fine

MVNU0023
18ct, rhodium plated
Medium

MVNU0024
18ct, rhodium plated
Broad

Sidecar Streamliner Black Pearl

MVNUF122
18ct, rhodium plated
Extra Fine

MVNUF123
18ct, rhodium plated
Fine

MVNUF124
18ct, rhodium plated
Medium

MVNUF125
18ct, rhodium plated
Broad

**Sidecar Streamliner
Black Lacquer / Chassis**

MVNUF117
18ct, rhodium plated
Extra Fine

MVNUF114
18ct, rhodium plated
Fine

MVNUF115
18ct, rhodium plated
Medium

MVNUF116
18ct, rhodium plated
Broad

Sidecar Streamliner Gold Plate

MVNUFF10
18ct yellow gold
Extra Fine

MVNUF111
18ct yellow gold
Fine

MVNUF112
18ct yellow gold
Medium

MVNUF113
18ct yellow gold
Broad



Range Plan SS11

Novelties

Novelties are an important and interesting category for dunhill. dunhill continuously strives to provide novelties that underline the exceptional quality and craftsmanship for which the brand is renowned.

Combinations of luxurious materials, clever and innovative executions of design – these are the reasons that dunhill novelty items have proved year after year to be a highly valued part of dunhill's offer to customers.

SS11



QGL1484
Zip top case

SS11



QGL1482
Single Pen Case

SS11



QGL1483
Double Pen Case

SS11



QGL1485
Travel Watch Case



SS11



QGL1486
I-Phone case

SS11



QGL1487
Blackberry Case

SS11



QGL0179

Solar Charger
Unit and Case

SS11

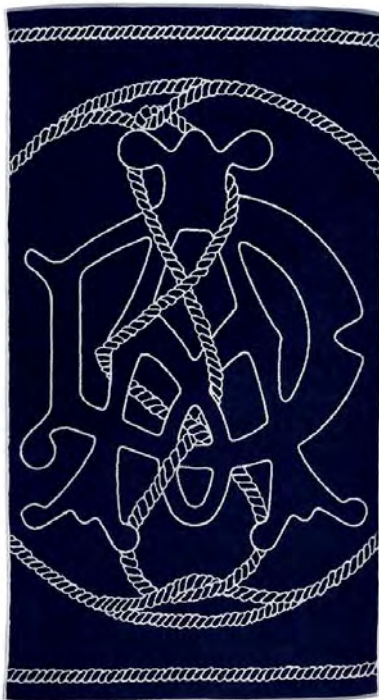

QGL0175

Beach Towel and Bag



QGK0169

Biometric Wallet



QGD0323

Tradition Hunters Flask



QGD0321

Tradition Hip Flask with Screw Cap
and Cowhide Bridle Leather

11.5 x 9.5 x 2.5 cm



QGH2006

Tri-fold Umbrella with Case



QGD2001

Sidecar Tube Umbrella



QGD2005

Sidecar Golf Umbrella



QGJ0805

Small Shagreen Cufflinks Box



QGH0803

Shagreen Cufflinks Box



QGH0804

Shagreen Watch Box

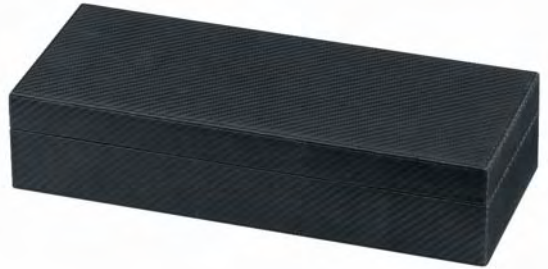

QGJ1431

Small Dunhill Chassis Watch Box

33.6 x 14 x 7.5 cm



QGJ1432

Large Dunhill Chassis Watch Box

33.6 x 24.8 x 7.5 cm



QGK1429

Leather Cufflinks Box
Dunhill Chassis Carbon Fibre Print
Leather

8.2 x 8.2 x 4.4 cm



QGK1430

Leather Cufflinks and Watch Box
Dunhill Chassis Carbon Fibre Print
Leather

17.5 x 12 x 6 cm



QGK1433

Dunhill Chassis Travel
Holds 2 Sets of Cufflinks



QGH8718

Sterling Silver Chalk Holder



QGJ1023

Desk Tower Game



QGD0131
 Poker Set
 Wood, lacquer, microfibre
 27.5 x 17 x 4.5 cm



QGD0325
 Tradition
 Mahjong Set

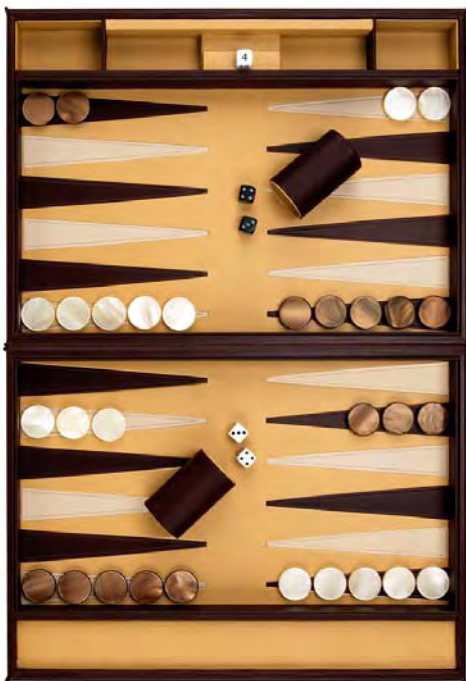

QGD0327
 Tradition Backgammon
 46 x 33.5 x 8 cm





QGJ0806

Shagreen Rubik's Cube



QGH0801

Shagreen Games
Compendium



QGD0331

Tradition Chess Set

50 x 50 x 5 cm



QGK1027

Poker Cards

'AD' logo

Polished carbon fibre box

19.5 x 13.5 x 4 cm

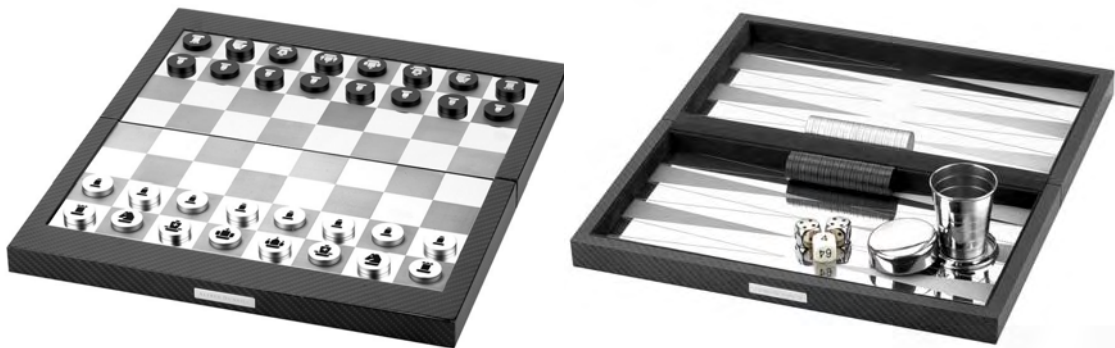

QGK1221

Travel Game

Polished carbon fibre box

31.5 x 17 x 4.5 cm



QGG0181
Score 4 Game



QGG1303
GLOBE WITH SENTRYMAN
BASE



Range Plan SS11

ADV8 Black

ADV8 Black is a stylistic and casual, masculine collection with a number of interesting design features.

Drawing inspiration from dunhill's Motorities heritage, a soft yet durable cowhide leather fabricates this range. The LLG range is complemented by an embossed leather trim with raised dotted detail which gives the pieces a superb tactile quality, whilst a three-hole circular cut-out motif directly references the dunhill driving gloves, adding to the visual impact and giving each of the pieces a strong family connection.

In typical dunhill style, this range boasts superior functionalities which include a fully adjustable and detachable padded shoulder strap in tonal webbing on the Double Zip Briefcase or a comfort grip handle on the handsomely proportioned Medium Holdall. Flat compartments and zip pockets in hard wearing micro fibre will store all essentials in each style, secured with easy to open double pull zips in brushed palladium or a magnetic clasped flapped closure on the North/South design.

The collection extends to a range of elegant and understated small leather goods, boasting contrast stitching and the tactile, yet subtle, addition of the trademark embossed dotted trim within the interior.

The ADV8 Black collection is made in Spain.

ADV8 Black - Small Leather Goods



L2G230A
Billfold
8 CC pockets
11.5 x 10 cm



L2G232A
Billfold
4 CC pockets and coin purse
9.5 x 12.5 cm



L2G247A
Business Card Case
8 x 11.5 cm



ADV8 Black - Small Leather Goods



L2G231A

ADV8 Billfold 6CC & 2ID

10 x 9 cm



L2KB45A

ADV8 Black Organiser

15 x 22 x 4 cm

ADV8 Black - Large Leather Goods



L3KB25A
24 Hours bag
43 x 31 x 16 cm



L3G241A
Double Zip Briefcase
41.5 x 31 x 10.5 cm



L3G260A
North/South Bag
21 x 26.5 x 6.5 cm



L3G265A
ADV8 Messenger Bag
34.5 x 28.5 x 9 cm



L3J981A
ADV8 Single Zip Briefcase
41 x 30 x 7 cm



Range Plan SS11

ADV8 Brown

ADV8 Brown is a stylistic and casual, masculine collection, featuring a brown re-working of the signature ADV8 leather, combined with a number of interesting design features.

Drawing inspiration from dunhill's Motorities heritage, a soft yet durable cowhide leather fabricates this range. This is complemented by an embossed brown leather trim with raised dotted detail which gives the pieces a superb tactile quality, whilst a three-hole circular cut-out motif directly references the dunhill driving gloves, adding to the visual impact and giving each of the pieces a strong family connection.

In typical dunhill style, this range boasts superior functionalities which include a fully adjustable and detachable padded shoulder strap in tonal webbing on the Double Zip Briefcase or a comfort grip handle on the Holdall. Flat compartments and zip pockets in hard wearing micro fibre will store all essentials in each style, secured with easy to open double pull zips in brushed palladium or a magnetic clasped flapped closure on the Messenger and North/South designs.

The ADV8 Brown collection is made in Spain.

ADV8 Brown - Large Leather Goods



L3K522B
Holdall
49 x 32 x 24 cm



L3K541B
Double Zip Briefcase
41 x 31 x 12 cm



L3K560B
Small North/South Bag
20 x 25 x 5.5 cm



L3K565B
Messenger Bag
34 x 25.5 x 8 cm



L3K581B
Single Zip Briefcase
41 x 31 x 7 cm

ADV8 Brown - Small Leather Goods



L2K545B

ADV8 Brown Organiser

15 x 22 x 4 cm





Range Plan SS11

Avorities™ Leather

Avorities™ Leather has been designed to build on the success of the very commercial nylon canvas Avorities™ collection.

It provides a fantastic alternative for the customer who wants a lightweight, durable, and functional travel piece, but in full leather. These black tumbled full grain leather pieces feature a black and green cotton lining and brushed palladium plated fittings.

Functionality and meeting the particular demands of the travelling businessman were important considerations during the design and development of this luggage collection. That is why there are many additional features such as shirt pockets and belt bags.

Avorities™ Leather - Large Leather Goods



QB6040A
Single Zip Document Case
40 x 29 x 9 cm



QB6020A
North/South Bag
23 x 27 x 10 cm



QB6090A
Avorities Leather Double Zip D/C
39.5 x 28.5 x 14 cm



L3K496A
Avorities Leather Small Rucks
30 x 39 x 17 cm



QB5595A
Avorities Leather SML Touring
37.5 x 33.5 x 16.5 cm

Avorities™ Leather - Large Leather Goods

SS11



L3L181A

Avorities 2.0 Single Zip Briefcase

40 x 31.5 x 9 cm

SS11



L3L141A

Avorities 2.0 24 Hours Briefcase

43 x 32 x 20 cm

SS11



L3L159A

Avorities 2.0 Vertical Messenger

31 x 35 x 10 cm

SS11



L3L160A

Avorities 2.0 North South Bag

24.5 x 27 x 7.5 cm



Range Plan SS11

Bladon Black

dunhill is delighted to introduce an extension to the successful Bladon range of durable yet elegant leather luggage. Designed to keep up with the demands of the modern, intelligent traveller, the exquisitely crafted Bladon Black collection embraces functionality with timeless design – in versatile and masculine black vegetable tanned leather.

Bladon takes its name from the English village where Sir Winston Churchill, one of dunhill's most iconic and loyal customers, is buried. Further drawing on the brand's heritage, premium leather has been expertly crafted to the same standards that Alfred himself instilled over 100 years ago. The choice of distinctive cowhide leather ensures each piece is unique – with every cut of hide presenting variations in textures and shades, each piece which will develop its own character with age.

For the culturally astute, this relaxed travel collection provides alternatives to more formal and solid business cases. To emphasise the masculine appearance, each design uses solid brass hardware and is lined in black cotton twill.

Bladon Black – Large Leather Goods



L3K925A
24 Hour Bag
43.5 x 30 x 16 cm



L3K922A
48 Hour Bag
52.5 x 35.5 x 19.5 cm



L3K981A
Single Zip Briefcase
40 x 32 x 7 cm

Bladon Drill Satchel

SS11



L3L880N

Bladon Drill Satchel

39 x 35 x 11 cm

SS11



L3L880E

Bladon Drill Satchel

39 x 35 x 11 cm



Range Plan SS11

Bladon Tan

With a history of creating beautifully crafted and durable leather luggage for almost 120 years, dunhill presents the Bladon Tan leather collection. Tanned leather with a masculine, natural grained appearance is crafted into timelessly elegant but always functional luggage.

Honouring the brand's esteemed British heritage, Bladon takes its name from the English town where Sir Winston Churchill is buried - a national icon who was a faithful customer of dunhill. Each of the three styles in the Bladon Tan collection are destined to become heirlooms, with the designs respecting every demand of the modern luxury traveller. The resilient vegetable tanned cowhide leather ensures each piece is individual - with every cut of hide presenting variations in marks and shades which will darken with age, taking on a soft and rich patina over the years.

Providing a more relaxed alternative to the suitcase or executive trolley, the range features various day bags to carry everything from passports to phones, keys to documents. Each design uses brushed stainless steel hardware and is lined in natural white twill.

Bladon Tan - Large Leather Goods



L3J325T
24 Hour Bag
43 x 30 x 16 cm



L3J381T
Single Zip Briefcase
40 x 32 x 7.5 cm



Range Plan SS11

Cordovan

An exceptional and rare leather due to its unique source and treatment, dunhill present a concise collection of Cordovan small leather pieces for Spring Summer 2011. Elegant dunhill designs are crafted using Genuine Cordovan Shell which is considered to be the most impermeable leather known to man and has an exquisitely glossy finish, durability and flexibility.

Although originating in Cordoba, Spain, the dunhill Cordovan Leather range uses skins sourced from one of only three tanneries left in the world to undertake the traditional and specific operations needed to produce Shell Cordovan. The Horween Leather Company in Chicago, Illinois have over 100 years of expertise and treat every skin – which comes only from the rump of a horse – with premium oils and dyes applied by hand. Genuine Shell Cordovan is the art of tanning at its finest. The irregular oval shaped shells are hand tanned, stuffed, shaved, and then polished – a process taking nine months.

The dunhill Cordovan Lace Up shoes present a classic rounded style in richly dyed burgundy Shell Cordovan complemented by a welted leather sole and subtle tone on tone stitching and laces. Traditionally Cordovan is used only on footwear but dunhill have diversified to include other small leather pieces. A Simple Belt is hand stitched to join three panels of Cordovan with a simple antique silver buckle. An elegant Coat Wallet or Travel Card Case is offered along with a Billfold wallet with room for either 8 credit cards or 4 cards and coin purse.

Once fully treated in Chicago, the Cordovan is then shipped to Italy to be crafted into the dunhill designs. Due to the unique nature of the skin, each piece will develop its own character and patina as it's cherished over the years.

Cordovan - Small Leather Goods

SS11



L2L210B

Coat Wallet 10CC with Zip

19 x 9.5 cm



SS11



L2L230B

Billfold 8CC

11.5 x 9.5 cm



SS11



L2L232B

Billfold 4CC & Coin Purse

10.5 x 9.5 cm



Cordovan - Small Leather Goods

SS11



L2L240B

Simple Card Case

7 x 21 cm

SS11



L2L277B

Travel Card Case

15 x 9.5 cm



Range Plan SS11

d-Eight Grey

Featuring the unique signature pattern of dunhill, the dunhill d-Eight Grey range is launched, defined by a grey re-working of the signature fabric. Detailed with black leather trim, the grey PVC is an updated fabric and the brushed gunmetal hardware adds a further luxury essence and perfectly complements the grey shade.

The dunhill d-Eight logo is now strongly attached to the luxury brand, and is a subtle but easily recognisable aspect to these pieces. This collection should also work to increase the global appeal of the d-Eight series.

The range is aimed at a younger, more stylistically aware customer.

d-Eight Grey - Small Leather Goods



L2F132Z

Billfold

4 CC pockets and coin purse

13 x 9.5 cm



Range Plan SS11

Chassis Navy

The celebrated dunhill Chassis leather collection is reinvented for Spring Summer 2011 with the addition of the Chassis Blue collection of large and small leather pieces. Realised in a luxurious midnight blue the iconic Chassis collection is given a casual edge and is ideal for the luxury traveller. The Chassis Blue collection retains the practicality that comes from innovative leather which is used to create the range - printed with a carbon fibre design, it is incredibly durable and scratch and water resistant.

*The large **24 Hour Case** is designed as a companion for the modern traveller with internal functionality such zip pockets, key ring holders and phone pockets. The **Zippered Messenger** epitomises the relaxed nature of the range with a cross body navy shoulder strap and side buckle detail whilst the masculine and compact **Reporter** is a new addition to the Chassis range.*

Elegant yet practical and an alternate option to the traditional black or brown staples of a gentleman's accessories, the Chassis Blue small leather goods are comprised of two billfolds, a coat wallet and business card case..

Dunhill Chassis Navy - Small Leather Goods

SS11



L2L510N

Coat Wallet 10CC with Zip

19 x 9.5 cm



SS11



L2L530N

Billfold 8CC

11.5 x 9.5 cm



SS11



L2L531N

Billfold 6CC & 2 ID

11.5 x 9.5 cm



Dunhill Chassis Navy - Small Leather Goods

SS11



L2L532N

Billfold 4CC & Coin Purse

10.5 x 9 cm

SS11



L2L547N

Business Card Case

11 x 8 cm

Dunhill Chassis Navy - Large Leather Goods

SS11



L3L525N

Vertical Holdall

40 x 39.5 x 17 cm

SS11



L3L566N

Messenger Bag with Zip

35 x 27 x 12 cm

SS11



L3L595N

Reporter Bag

32 x 23 x 15.5 cm



Range Plan SS11

dunhill Chassis

dunhill Chassis is a fantastic new leather goods collection.

With close links to dunhill's great Motorities heritage, the cult carbon fibre effect on this leather is created using high heat and a vacuum effect with mechanical and chemical bonding. This leather effect can also be found on the dashboards of some leading supercars, and is not only incredibly tactile but also scratch resistant and water repellent for added functionality.

Totally unique and completely dunhill, the range includes seven shapes in SLG and three shapes in LLG.

The dunhill Chassis collection is made in Spain.

dunhill Chassis - Small Leather Goods



L2H230A
Billfold
8 CC pockets
11.5 x 9.5 cm



L2H232A
Billfold
4 CC pockets and coin purse
11.5 x 9.5 cm

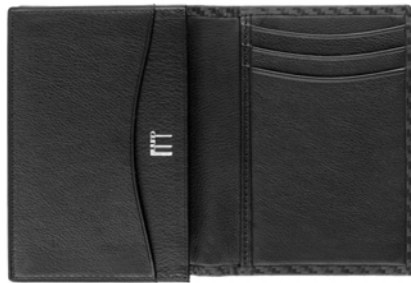

L2H247A
Business Card Case
11 x 8 cm

dunhill Chassis - Small Leather Goods



L2J214A
Travel Companion
Double zip
21 x 13 x 4 cm



L2H231A
Billfold
6 CC pockets and 2 ID windows
11.5 x 9.5 cm

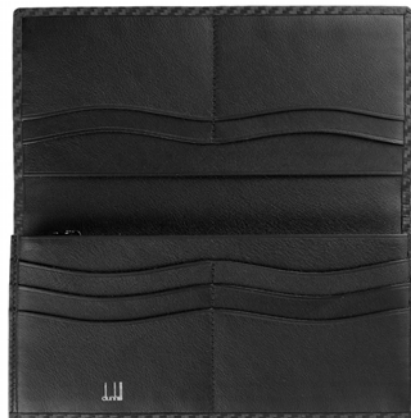

L2H210A
Coat Wallet
10 CC pockets and zip
19 x 9.5 cm

dunhill Chassis - Small Leather Goods



L2H250A
7 Hook Key Case
6.5 x 11 cm

SS11



L2L540A
Simple Card Case
7 x 10.5 cm

dunhill Chassis - Large Leather Goods

SS11



L3J281A
Single Briefcase
40 x 30 x 6.5 cm



L3L541A
Dunhill Chassis Double Zip Brief
40 x 30 x 9 cm



L3J260A
North/South Bag
With flap
24 x 26.5 x 8.5 cm



L3J265A
Dunhill Chassis Messenger Bag
37 x 28 x 8 cm



L3J220A
Small Holdall
49 x 26 x 27 cm



Range Plan SS11

Heist Traveller

The Heist Traveller collection was developed to update dunhill's current business offer with highly functional and practical business/travel styles in modern materials and classic shapes.

The range is realised in a functional, black printed PVC material with rubberised black leather trims and black nylon webbing detail.

There are 4 LLG styles in the range with huge functionality and added value qualities. The double zip document case comes complete with easily accessible travel umbrella, whilst a folding suit carrier and North/South bag complete the offer.

A range of small leather goods are now also available to complement the collection.

Heist Traveller - Large Leather Goods



L3K274A
Trifold Suit Carrier
57 x 15 x 3 cm



L3K265A
Messenger Bag
38 x 30 x 9 cm



L3H160A
North/South Bag
23 x 28 x 9 cm



L3H141A
Double Zip Document Case
With umbrella
41.5 x 31 x 13 cm

Heist Traveller - Large Leather Goods



L3H155A

Heist Traveller Small Trolley

39 x 53 x 25 cm (including wheels)



L3H170A

Heist Traveller Ruck Sac

35 x 47 x 18 cm



Range Plan SS11

Micro d-Eight Brown

The Micro d-Eight series is a further evolution of the iconic d-Eight family, featuring a new version of the dunhill d logo applied in an extremely discreet way - a micro execution of the iconic d-Eight pattern embossed onto the leather. Now the collection is further expanded by the Micro d-Eight Brown range, featuring dark brown calfskin, which is again embossed to give these pieces a tactile and interesting quality.

The collection features a strong selection of classic styles alongside some interesting variations. With dunhill's typical attention to detail, the traditional offering of wallets is expanded to a choice of a coat wallet as well as three billfold styles, taking into consideration the gentleman's individual preference to carry coins or ID cards as well as his bank notes and cards. A business card case completes the collection. Sleek and understated, dunhill's Micro d-Eight Brown collection presents small leather goods that are elegantly stylistic as well as functional.

The Micro d-Eight Brown collection is made in Italy.

Micro d-Eight Brown - Small Leather Goods



L2K310B
Coat Wallet
10 CC pockets and zip
19 x 9 cm



L2K331B
Billfold
6 CC pockets and 2 ID windows
11.5 x 9.5 cm



L2K330B
Billfold
8 CC pockets
11.5 x 9 cm



Micro d-Eight Brown - Small Leather Goods



L2K332B

Billfold

4 CC pockets and coin purse

10.5 x 9 cm



L2K347B

Business Card Case

11 x 7.5 cm



Range Plan SS11

Micro d-Eight

This collection is a further evolution of the iconic d-Eight family, featuring a new version of the dunhill d logo applied in an extremely discreet way - a micro execution of the iconic d-Eight pattern embossed onto the leather.

The use of embossed calfskin gives these pieces an excellent tactile quality, and offers something a little different to the usual plain black SLG. Subtle branding in palladium and black lacquer plated hardware adds a final masculine touch to the outer of each piece whilst the contrast finish of smooth leather is used internally, complemented by black signature jacquard lining.

The collection features a strong selection of classic styles alongside some interesting variations. With dunhill's typical attention to detail, the traditional offering of wallets is expanded to a choice of a coat wallet as well as two billfold styles, taking into consideration the gentleman's individual preference to carry coins or ID cards as well as his bank notes and cards. A business card case completes the collection. Sleek and understated, dunhill's Micro d-Eight collection presents small leather goods that are elegantly stylistic as well as functional.

The Micro d-Eight collection is made in Italy.

Micro d-Eight - Small Leather Goods

L2G330A
Billfold
8 CC pockets
11.5 x 9 cm



L2G332A
Billfold
4 CC pockets and coin purse
10.5 x 9 cm

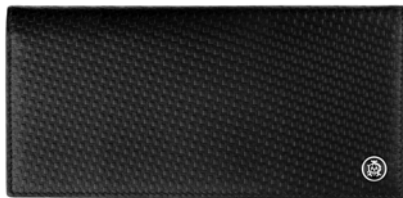

L2G310A
Coat Wallet
10 CC pockets and zip
19 x 9 cm



L2G347A
Business Card Case
11 x 7.5 cm



Micro d-Eight - Small Leather Goods



L2G314A

Micro D-Eight DBL travel companion

21 x 13 x 4.5 cm



Micro d-Eight - Large Leather Goods

SS11



L3L640A

Micro D-Eight double document case

38 x 30.5 x 10 cm

SS11



L3L680A

Micro D-Eight single document case

38 x 30.5 x 6.5 cm

SS11



L3L690A

Micro D-Eight pochette with lock

26.5 x 18.5 x 6.5 cm



Range Plan SS11

Sidecar Gunmetal

In 1915, Dunhill's Motorities patented and began manufacturing a triangular form of motorcycle sidecar chassis, catering to the gentleman motorcyclist. Inspired by these exceptional sidecars, dunhill has introduced a new range to the family of dunhill Sidecar luxury business luggage and small leather goods.

This classic and elegant range is realised in black leather and distinguished by its luxurious hardware – brushed gunmetal. There is a rich variety of shapes and forms in this range, including 2 document cases and a lockable pochette on the large leather front, as well as a large range of small leather goods.

These pieces have great strength in order to meet the high expectations and demands of working leather goods whilst being lightweight and functional for the modern business user.

The Sidecar Gunmetal collection is made in Italy.

Sidecar Gunmetal - Small Leather Goods



L2F230A
 Billfold
 8 CC pockets
 12.5 x 9.5 cm



L2F232A
 Billfold
 4 CC pockets and coin purse
 12 x 9.5 cm



L2F210A
 Coat Wallet
 10 CC pockets with zip
 19.5 x 9.5 cm

Sidecar Gunmetal - Small Leather Goods



L2F214A

Travel Companion

Double zip

21 x 13 x 4.5 cm

Sidecar Gunmetal - Large Leather Goods



L3F290A

Pochette

2 gusset with lock

26.5 x 17.5 x 6.5 cm



L3F240A

Double Document Case

With lock

40 x 28.5 x 9 cm



L3F280A

Single Document Case

With lock

38 x 27 x 6.5 cm



Range Plan SS11

Sidecar

In 1915, Dunhill's Motorities patented and began manufacturing a triangular form of motorcycle sidecar chassis, catering to the gentleman motorcyclist. Over 85 years later, inspired by these exceptional sidecars, dunhill has introduced a striking range of luxury business luggage – dunhill Sidecar.

The black-brown colour of the unique grained cowhide leather, which dunhill refers to as “bitter chocolate”, is smart and modern – and always correct for business. The pieces are light in weight, yet have great strength to meet dunhill's standards for workable luggage.

The grained cowhide is highly durable and is treated with anti-scratch properties to ensure impeccable appearance.

The Sidecar collection is made in Italy.

Sidecar - Small Leather Goods



FP3020E
Billfold
8 CC pockets
12.5 x 9.5 cm



FP8000E
Coin Purse
8 x 9.5 cm



FP3070E
Billfold
4 CC pockets and coin purse
12 x 9.5 cm



FP5020E
7 Hook Key Case
7 x 10 cm

Sidecar - Small Leather Goods

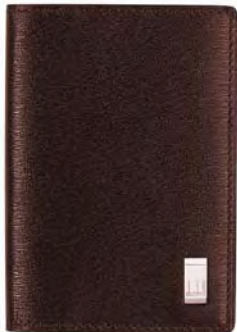

FP4700E
Business Card Case
2 CC pockets
8 x 11 cm



FP1010E
Yen Wallet
10 CC pockets and zip
19.5 x 9.5 cm



FP9790E
Travel Companion
Double zip
21 x 13 x 4.5 cm



FP4000E
Simple Card Case
10 x 7 cm

Sidecar - Large Leather Goods



FA8010E
Single Document Case
38.5 x 26 x 5.5 cm



FA6060E
Double Document Case
40 x 28.5 x 8.5 cm



FA9000E
Pochette
2 gusset with lock
26.5 x 18 x 7 cm

Sidecar - Small Leather Goods



FP1240E

Sidecar Billfold 6CC & 2 I.D Window

12.5 x 9 cm

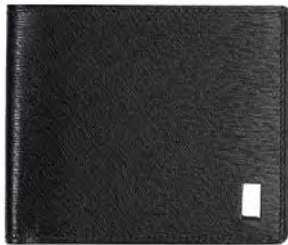

FP1250E

Sidecar Billfold 14CC

11.5 x 9.5 cm



Range Plan SS11

Windsor

Reflecting a provenance of over 120 years of expert leather craftsmanship, dunhill introduces the Windsor Large and Small Leather collection. This comprehensive range comprises of four Large Leather and six Small Leather designs in black canvas and leather, considering every requirement of the modern business traveller.

Characterised by the iconic vintage 'AD' logo subtly applied as a repeat motif to soft coated canvas, every piece is complete with black vegetable tanned leather trim and brushed gunmetal hardware. The masculine materials balance with elegant designs, each intelligently equipping the dunhill man with absolute functionality yet timeless style.

Each Large Leather piece is lined in grey microfibre. The handsome 24 Hour Bag features a front flat pocket with magnetic snap closure and zipped back pocket, which complement a main zipped compartment containing a zipped and a flat pocket, a keyfob holder and two phone pockets. A Double Zip Briefcase extends the design with an additional padded back compartment with a large flat pocket for a laptop or documents. The casual Messenger with Flap or smaller North South Bag with Flap offer a padded shoulder strap and magnetised flap to secure contents within a front flat pocket and main compartment boasting a zipped pocket, key fob holder and two phone pockets.

A wide range of Small Leather Goods complete this functional collection.

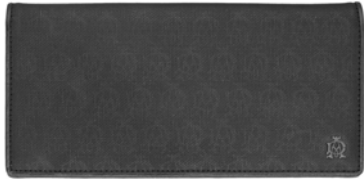
Windsor - Small Leather Goods

L2K710A
Coat Wallet
10 CC pockets and zip
10 x 19.5 cm



L2K714A
Travel Companion
Double zip
21 x 13 x 4.5 cm

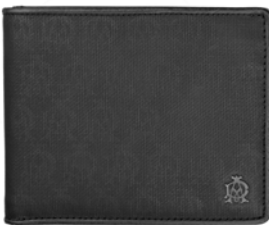

L2K730A
Billfold
8 CC pockets
12 x 9.5 cm



Windsor - Small Leather Goods

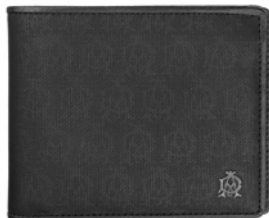

L2K732A

Billfold

4 CC pockets and coin purse

12 x 9.5 cm

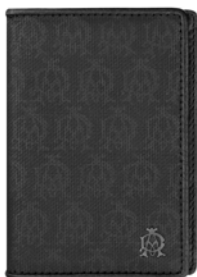

L2K747A

Business Card Case

8 x 11 cm

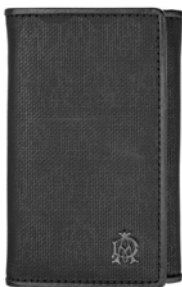

L2K750A

7 Hook Key Case

7 x 10.5 cm

Windsor - Small Leather Goods



L2K731A

Windsor Billfold 6CC & 2 ID

12 x 9.5 cm



L2K780A

Windsor Coin Purse

10.5 x 7.5 cm



Windsor - Large Leather Goods



L3K725A
24 Hour Bag
41.5 x 40.5 x 17 cm



L3K741A
Double Zip Briefcase
41 x 32 x 9 cm



L3K760A
North/South Bag
With flap
25 x 25.5 x 9.5 cm



L3K765A
Messenger Bag
With flap
37.5 x 27 x 8 cm



L3K791A
Windsor Pochette With Zip
27 x 17 x 6 cm



Range Plan SS11

York

This collection offers a selection of well proven and popular styles that feature excellent and well thought-out functionality.

These versatile casual or formal pieces are made from soft tumbled leather which has an attractive and tactile finish.

All the items in this collection are made in Italy.

SS11



L2L710A

Coat wallet
Cowhide & Stainless steel

20 x 9 cm



SS11

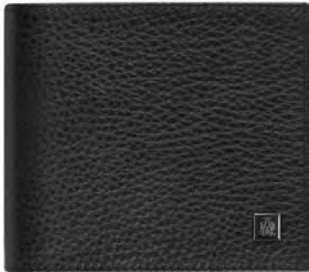

L2L730A

Billfold 8cc
Cowhide & Stainless steel

11 x 9.5 cm



SS11

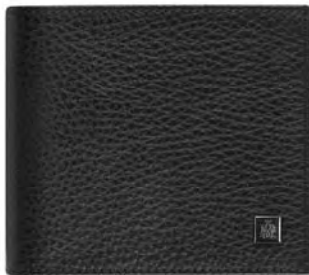

L2L731A

Billfold 6cc & 2ID
Cowhide & Stainless steel

11 x 9 cm



York - Small Leather Goods

SS11



L2L732A

Billfold 4cc and coin purse
Cowhide & Stainless steel

11 x 9.5 cm

SS11

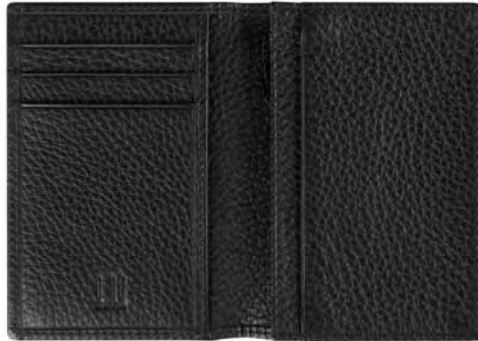

L2L747A

Business card case
Cowhide & Stainless steel

11.5 x 7.5 cm

SS11



L2L750A

Hook key case
Cowhide & Stainless steel

10 x 7 cm



Range Plan SS11

Belts

dunhill has a long tradition of supplying menswear and leather goods to the luxury market, and these come together when designing and producing these belt collections. The same craftsmanship goes into the making of the leather part of the belt as you will find in dunhill bags and wallets, and many of the belts are reversible. The buckles are brass with palladium or gold plating and can be released from the leather to make them fully adjustable for length.

All dunhill belt buckles are made of brass which gives a weighty, luxury feel to the products. The buckles are mostly hand polished.

All dunhill belts and their components are made in Italy.

SS11



BPL120A

Diamond pattern frame
Black cowhide
Golden buckle

SS11



BPL145A

Faceted lacquer and palladium
buckle
Black cowhide
Stainless steel and black lacquer

SS11



BPL150A

Leather insert belt
Black cowhide
Black cowhide and
palladium buckle

SS11



BPL165A

Micro d-Eight Buckle
Black cowhide
Gunmetal

SS11



HPL100A

Classic reversible Belt
Black cowhide
Stainless steel

SS11



HPL105A

Rounded buckle engine
Turned reverse
Cowhide
Stainless steel

SS11



HPL110A

Carbon Fibre insert buckle
Cowhide
Gunmetal

SS11



HPL125A

Curved engine belt
Cowhide
Stainless steel

SS11



HPL130A

Curved engine rose
gold belt
Cowhide
Rose gold

SS11



HPL135A

Double prong belt
Cowhide
Gunmetal buckle

SS11



HPL140A

Palladium frame belt
Cowhide
Palladium

SS11



HPL155A

Windsor Dunhill
Lacquer belt
Coated canvas
Cowhide
Gunmetal

SS11



HPL160A

Bladon leather insert
belt
Cowhide
Palladium buckle



HPK145A
Rounded Rectangular Carbon Fibre Reversible
Polished stainless steel buckle
Black carbon fibre print cowhide



BPK255A
'AD' Vintage
Black PVD buckle
Black rubberised / Black smooth cowhide



BPK305A
'AD' Facet Gunmetal
Polished gunmetal buckle
Black smooth cowhide



HPK210A
Single Ring Palladium
Polished palladium buckle
Black smooth cowhide



HPK220A
Simple Antique
Silver buckle
Black smooth cowhide



HPK235A
Diamond Pattern Tongue
Palladium
Polished palladium buckle
Black / Brown smooth cowhide



HPK275A
Trimetal
Gunmetal, palladium and black resin buckle
Black Saffiano / Black smooth cowhide



BPK155A
'AD' Radiator
Polished brushed stainless steel buckle
Black / Brown smooth cowhide



HPK320B
Curved Bridle
Antique natural brass buckle
Brown smooth cowhide



BPK100A
'AD' Rotating Micro d-Eight
Brushed gunmetal and cowhide buckle
Black micro d-eight / Brown smooth cowhide



BPK135A
Rivet Plaque Palladium
Black print cowhide
Brushed Palladium



BPK110A

Texalium Panel
Polished gunmetal buckle
Black cowhide



BPK125A

Engine turning oval
plaque
Cowhide and Gunmetal



BPK130A

Rivet Frame Buckle
Cowhide and Brushed
Gunmetal



HPK220A

Simple Antique
Silver Belt
Black cowhide and
Antique silver



BPK205A

Dunhill Lacquer Panel
Buckle
Black cowhide and black
lacquer



BPK250A

Line Panel Palladium
Buckle
Black cowhide
Polished and brushed
palladium



BPK260A

Alfred Dunhill
Vintage Logo
Black Micro d-8
cowhide
Brushed Gold



HPK215A

Brass Bridle Belt
Black smooth
cowhide
Polished Brass



HPT010A

Classic Palladium Reversible
Polished palladium plated
buckle
Black smooth / Dark brown
saffiano print cowhide



HPW100A

Twist Square Palladium
Reversible
Polished palladium plated buckle
Black smooth / Dark brown
cowhide



HPF124A

Curved Engine Turned
Rivet Reversible
Polished palladium buckle
Black printed / Black
smooth cowhide



HPF116A

Square Engine Turned Rivet
Reversible
Polished palladium buckle
Black printed / Black smooth
cowhide



HPD210A

Twist Rectangular Reversible
Polished ruthenium plated
buckle
Black smooth / Black saffiano
print cowhide



BPE100A

Classic Facet Palladium
Polished palladium buckle
Black vegetable tanned cowhide



BPJ275A

Faceted Solid 'AD' Lacquer
and Palladium
Brushed palladium and black
lacquer buckle
Black smooth / Black Saffiano
cowhide



BPZ050A

Sliding Doors Palladium
Lacquer Reversible
Polished brushed palladium
and lacquer buckle
Black saffiano print / Black
smooth cowhide



BPB150A

Double Frame Lacquer
Palladium Reversible
Polished palladium plated and
black lacquer buckle
Black smooth / Brown Saffiano
print cowhide



HPH160A42

Carbon Engine Rivet
Gold
Black cowhide
Polished gold



HPH170A

Curved Engine Rivet
Carbon Fibre
Brushed gunmetal buckle
Black carbon fibre print /
Black smooth cowhide



BPJ220A

Carbon Fibre Gunmetal Panel
Polished gunmetal and carbon
fibre insert buckle
Black / Brown printed
cowhide



BPH120A

Carbon Fibre Leather Panel
Brushed palladium and carbon
fibre print cowhide panel buckle
Black carbon fibre print cowhide



HPJ245A

Twist Palladium Reversible
Polished palladium buckle
with twisting mechanism
Black smooth / Black printed
cowhide



HPJ250A

Twist Curved Reversible
Polished gunmetal buckle with
twisting mechanism
Black / Brown carbon fibre print
cowhide



BPD300A

Carbon Fibre Panel Reversible
Polished brushed gunmetal
plated buckle
Black printed / Black Saffiano
cowhide



BPV070A

Gold plated panel
reversible belt
Reversible black on
brown cowhide
Gold plate



BPD240A

Faceted palladium
and lacquer belt
Black cowhide
Black Lacquer
Palladium Plate



HPZ190A

Spoiler Palladium
Polished palladium plated buckle
Black grained cowhide with grey stitching



HPC060A

Classic Gunmetal Reversible
Polished gunmetal plated buckle
Black printed / Tan Saffiano print cowhide



HPH135B

Split Carbon Reversible
Brushed gunmetal buckle
Dark brown printed / Black printed cowhide



HPJ235A

Square Engine Turned Rivet
Matt gunmetal buckle
Black grained / Black smooth cowhide



HPG130B

Lacquered Rectangular
Palladium buckle
Dark brown printed / Black smooth cowhide



BCH315A

Stingray Black belt
Black stingray skin
Palladium buckle



BCG195A

New facet palladium belt
Black alligator skin
Palladium



BCB140B

Double Roll
Tongue Buckle
Alligator Skin
Palladium



Range Plan SS11

Shoes

Taking inspiration from the modernist style of London's Bloomsbury Group in the 1930s, the dunhill Spring Summer 2010 Footwear collection playfully subverts classic English designs.

The ease of dressing favoured by the experimental artists is reflected by casual styles and idiosyncratic details, distinguished by bursts of colour.

*The formal style of a traditional lace up appears in a more relaxed form as the **Contrast Welt Derby** shoes. Dark brown calfskin is coupled with a bold royal blue welt highlighting a natural leather sole and off white stitching. Navy waxed laces add an additional casual point of difference on the elegant and classic design. The same style is also presented in navy leather with a red welt and royal blue waxed laces or tan calfskin characterised by a navy welt and natural laces.*

*Updating another modern British classic, the **Desert Boots** are presented with a sturdy structure and welted white Vibram natural rubber sole offering durability. A contrast welt appears in bright red upon a navy suede design or navy accompanying grey suede. The welt is mirrored on each with a darkened hand painted layer along the bottom of each upper – exaggerating the stacked appearance and heightening the graphic look. A choice of bright yellow or red flat cotton laces further add to the boots' colourful look.*

SS11



L1L350N

Navy leather trainer
With navy sole
Rubber sole

SS11



L1L350N

Off white leather trainer
With navy sole
Rubber sole

SS11



L1L500W

Off white desert boots
Leather & Rubber



L1K600B

Brown Brogue Lace Up
Smooth brown calfskin, leather
sole, brown laces



L1K605B

Stitched Vamp Lace Up
Smooth brown calfskin, welted
leather sole, brown laces



L1K600A

Black Brogue Lace Up
Smooth black calfskin, welted
leather sole, black laces



L1K200A

Formal Loafer
Smooth black calfskin, welted
leather sole



L1K350A

Windsor Trainer
AD printed coated canvas with
black smooth leather, black rubber
sole, black laces



L1D600B

Formal Punched Brown Lace Up
Antique brushed brown calfskin,
leather sole, brown laces



L1F603A

Formal Punched Black Lace Up
Black box calfskin, leather sole,
black laces



S21110L

Tudor Tubular Loafer
Dark brown calfskin, rubber sole



L1J650B

Norwegian Brown Lace Up
Brown grained calf skin, brown leather
and black rubber sole, blue and brown
laces



L1H610A

Soft leather lace up
Black Leather
Rubber sole



S21110L

Tudor Tubular Loafer
Black calfskin
Rubber sole



L1E317A

D-Eight PVC Trainer
PVC & Leather
Rubber sole

SERVICE CENTRES

W L
A I L J
T G E E
C H A L
H E P T L
E E E H E
S R N E R
S S S R Y

COUNTRY	ADDRESS	TELEPHONE/ FACSIMILE					
Australia	Richemont Australia Pty Ltd Level 9, Suite 2, 60 Elizabeth Street Sydney NSW2000, Australia	T: +61 (0) 2 8215 5500 F: +61 (0) 2 9215 5510	●	●	●	●	●
Austria	Herbert Beutler Feuerzeuglinik, Neustifgasse 61 A-1070 Wein, Austria	T: +43 15231415 F: +43 15231415		●	●		
Bahrain	MM Sharif Hatam & Sons Moda Mall, Manama Bahrain 469	T: + 973 17 536 369 F: +973 17 210339	●	●	●	●	●
Bulgaria	Novea Entrance B, Flat 4, Floor 1 1408 Sofia, Bulgaria	P: + 359 2 952 5906 F: + 359 2 295 24494	●	●	●	●	
Canada	GL Turcot Lte Le Marriott Chateau Champlain 1050 Rue de la Gaucheterie Ouest Montreal H3B 4CP Canada	T: +1 514 861 7823 F: +1 514 861 7823		●			
Canada	Richemont Canada Inc 4610 Eastgate Parkway Unit 1 Mississauga L4W 3W6 Ontario Canada	T: +1 905 602 0696 F: +1 905 602 6064	●		●	●	●
China	Dunhill China, Suites 3409-10 Citic Square 1168 Nan Jing Road West Shanghai 200041, China	T: +86 21 6445 9955 F: +86 21 6445 0202	●	●	●	●	●
China	Richemont Shanghai Customer Service Centre Room 501, 5th floor Evergo Tower Huaihai Zhong Road 1 Bao Quing Road Shanghai, China	T: + 86 21 6161 2804 F: + 86 21 6161 2800	●				
China	Richemont customer Services, Beijing Room 601, New World Centre North Office Tower 3B Chong Wen MenWai Street Beijing 100062, China	T: + 86 10 6709 4807 F: + 86 10 6709 4800	●				
China	Time Network Room 1206, 61 Renmin Road East Chengdu 610015 China	T: + 86 28 8671 3917 F: + 86 28 8672 1198		●	●	●	●
China	Time Network Room 901-902, Guangzhou Friendship Commercial Building 369 Huan Shi Dong Lu Guangzhou, 510095 China	T: + 86 20 8350 7128 F: + 86 20 8350 7138		●	●	●	●
China	Time Network Room 11K, Cross Region Plaza No. 899 Lingling Road Shanghai 200030 China	T: +86 21 64459955 F: +86 21 5425 8075		●	●	●	●
China	Time Network Room 1117, Office Tower 2 Sun Dong An Plaza 138 Wang Fu Jing Da Jie Dong Cheng District Beijing, 100006 China	T: +86 10 6525 6373 F: +86 10 6525 8075		●	●	●	●
China	Time Network 2018W, 2/F, Seibu Zhongxin City Plaza Shenzhen, 518030 China	T: +86 755 2598 7378 F: +86 755 2598 7389		●	●	●	●
Czech Republic	Carollinum Hodinarstvi-Klenotnictvi, Parizska 11, 11000 Praha 6 Czech Republic	T: + 420 224 810 890 F: +420 224 815 785	●	●	●	●	
Denmark	Scandanavian Tobacco Group Denmark Samsovej 30, B TV DK-8382 Hinnerup	T: + 45 43205504 F: +45 8629 6961		●			

SERVICE CENTRES

L
E
W
I
L
G
E
A
H
P
T
A
P
T
L
E
H
E
R
N
E
R
S
S
S
S
R
Y

COUNTRY	ADDRESS	TELEPHONE/ FACSIMILE	W	L	L	J
Egypt	Thomas Trade Egypt 37 El-Giza St. Heliopolis Cairo Egypt	T: +20 2 2451 4380	●	●	●	●
France	Alfred dunhill France, Centre SAV, 15 Rue de la Paix 75002 Paris France	T: + 33 1 42 615839 F: +33 1 42 606367	●	●	●	●
Germany	Pipe & Lighter Centre, Dorfstrasse 6 21521 Dassendorf, Germany	T: + 49 4104 969644 F: +49 4104 969645		●	●	
Germany	Scandinavian Tobacco Ein Bereich Der, Stanwell Nobel Vertriebs Gesellschaft MBH Hermann-Ritter Strasse 106 28197 Breman, Germany	T: +49 040 8407070		●		
Greece	Tzannes, 73-75 Nimphon Str, 16341 Ilioupolis Athens, Greece	T: + 30 210 994 5000 F: +30 210 995 3238	●	●	●	●
Hong Kong	Richemont Luxury Asia Pacific, 4th Floor, Crown Worldwide Building 9-11 Yuen On Street, Sha Tin N.T. Hong Kong	T: + 852 2635 0362 F: +852 2635 0260	●	●	●	●
Hong Kong	Richemont Luxury Asia Pacific, Quick Service G10-G13 Princes Building 10 Charter Road Hong Kong	T: + 852 2524 3663	●	●	●	
Italy	Richemont Italia Spa Via Ludovico Di Breme 44 20156 Milano, Italy	T: + 39 023 026 252 F: +39 023 026 655	●	●	●	●
Italy	Augusta Via di San Marcello 21 00187 Roma, Italy	T: +39 06 69200532 F: +39 06 6793123		●		
Japan	Richemont F&A Japan Limited Meijiya Ginza Building 3F 2-6-7 Ginza, Chuo-Ku Tokyo 104-0061, Japan	T: + 81 3 3562 1767 F: + 81 3 3562 2181	●	●	●	●
Korea	Korea Richemont Ltd, Customer Services 3rd Floor, 141-16, Chungdam Dong Gangnam-gu, Seoul 135 959, Korea	T: + 82 2 3440 5562 F: +82 2 518 4626	●	●	●	●
Kuwait	Yousuf Behbehani Establishment Shop no. 43 & 44 Mezzanine Floor, Behbehani Complex Sharw, Kuwait	T: + 965 2455063	●	●	●	
Lebanon	Wadih Mrad, PO Box 71171, Antelias	T: + 961 4404438 F: +961 4411003	●	●	●	
Malaysia	Richemont Luxury (Malaysia) SDN BHD, Suite 16-01 Manara HLA No.3 Jalan Kia Peng Kuala Lumpur, 50450, Malaysia	T: + 603 2176 5888 F: +5603 2176 5900	●	●	●	●
Netherlands	J Van Slingerland, Nieuwe Binnenweg 127 3014 GJ Rotterdam	T: + 31 104362044 F: +31 104361245		●	●	
New Zealand	Tauranga Horological Ltd RD3, Pyes PA Tauranga, New Zealand	T: + 647 543 2245 F: +647 543 4554	●	●	●	●
Portugal	Richdun SA Av Marques De Tomar N2 8ANDAR 1050 155 Lisbon	T: +351 210 1237 F: +351 210 134523	●	●	●	●

SERVICE CENTRES

W A T C H E S
L I G H T P E N S I L E
J E W E L L E R Y

COUNTRY	ADDRESS	TELEPHONE/ FACSIMILE					
Qatar	Ali Bin Ali Watches & Jewellery, Sadd Street Sadd Street Doha 75	T: +9 744 429 900	●	●	●	●	●
Russia	Altaris (Oriental Express) Bld 4, Str 3-4-5 UL Verkhniya Radischevskaya 109240 Moscow, Russia	T: + 7 495 981 4113	●	●	●	●	●
Saudi Arabia	Hussein Bakry Gazzaz & Co Ltd Gazzaz Head Office Building King Abdei Aziz Street PO Box 16666, Jeddah 21474	T: + 966 2 647 9799 F: +966 2 649 1555	●	●	●	●	
Saudi Arabia	Al Hussaini Trading Saudi Business Centre, 10th Floor PO Box 9083, Madinah Road Jeddah, 21413 Saudi Arabia	P: +966 2 652 6000 F: +966 2 653 6606	●	●	●	●	●
Singapore	Richemont Luxury (SG) Pte Ltd 390 Havelock Road #08-05/06 King's Centre Singapore 169662	T: + 65 6317 2588 F: + 65 6317 2599	●	●	●	●	●
South Africa	Vendome Distributors SA 1st Floor, Cedarwood House Ballywods Office Park Ballyclare Drive, Brynston Johannesburg 2021	T: +27 11 463 3368 F: +27 11 463 3549	●	●	●	●	●
Spain	Alfred dunhill France, Centre SAV, 15 Rue de la Paix 75002 Paris France	T: + 33 1 42 615839 F: +33 1 42 606367	●				
Spain	AD Comercio Exterior SA, Polig Industrial Malpica - Alfinden C/ Naranjo, Nava 8-10, La Puebla de Alfinden 50171 Zaragosa, Spain	T: + 34 976 108980 F: +34 973 108981		●	●	●	●
Switzerland	LN Industries, Divisions Produits de Luxe 46 Chemin de L'Etung, Case Postale 256 CH-1219 Chatelaine, Geneva, Switzerland	T: + 41 22 979 3700 F: +41 22 979 3750		●	●		
Taiwan	Alfred dunhill (Fashion Distributors) Ltd 2/F., No.10 Lane 39, Chung Shan North Road Sec. 2, Taipei, Taiwan	T: + 886 2 561 8228 F: +886 2 2561 8112	●	●	●	●	●
UAE	Rivoli Group PO Box 121 Dubai Room #303, Al Fahedi Street Mohammed Saleh Building Bur Dubai, UAE	T: + 9714 353 1400 F: + 9714 353 2342	●	●	●	●	●
UAE	AMC, Unit H-07, Dubai Airport Duty Free Zone PO Box 54646 Dubai, UAE	P: + 9714 299 0350 F: + 9714 299 0351	●	●	●	●	●
United Kingdom	Alfred Dunhill Limited 5 - 7 Mandeville Place London W1U 3AY	T: + 0845 458 0779 F: + 44 20 7838 8000	●	●	●	●	●
USA	Alfred Dunhill 545 Madison Avenue New York NY10022, USA	T: + 1 800 776 4053	●	●	●	●	●
USA	Authorised Repair Service 3450 Ashville Highway, Lower Level Hendersonville NC 28791, USA	T: + 1 828 6933212 F: + 1 828 6933213		●	●		

PROD CAT	SKU	GENERIC	OTHER INFO	DESCRIPTION	Franchise RP (JS model)	WS RP	APEX WS customers
BELTS	BCB140B42	BCB140		BELT CASUAL ALLIGATOR SKIN	x		
BELTS	BCG195A40	BCG195		NEW FACET PALLADIUM ALLIGATOR	x		
BELTS	BCH315A42	BCH315		STINGRAY BLACK BELT - 20MM	x		
BELTS	BCV200B40	BCV200		BELT P/PLATE DK BRWN SHINY ALL	x		
BELTS	BPB150A42	BPB150		BELT DOUBLE FRAME LACQUER PALL	x	x	x
BELTS	BPD240A42	BPD240		BELT FACETED PALL SOLID LACQUE	x		
BELTS	BPD300A42	BPD300		BELT CARBON FIBRE PANEL	x	x	x
BELTS	BPE100A42	BPE100		BELT CLASSIC FACET PALLADIUM	x	x	x
BELTS	BPJ220A42	BPJ220		CARBON FIBRE GUNMETAL PANEL	x	x	x
BELTS	BPK100A42	BPK100		AD ROTATING MICRO D-EIGHT	x	x	x
BELTS	BPK110A42	BPK110		TEXALIUUM PANEL	x		
BELTS	BPK125A42	BPK125		ENGINE TURN OVAL PLAQUE	x		
BELTS	BPK130A42	BPK130		RIVET FRAME GUNMETAL	x		
BELTS	BPK135A42	BPK135		RIVET PLAQUE PALLADIUM	x		
BELTS	BPK155A42	BPK155		AD RADIATOR BELT	x	x	x
BELTS	BPK205A42	BPK205		DUNHILL LACQUER PANEL	x		
BELTS	BPK250A42	BPK250		LINE PANEL PALLADIUM	x		
BELTS	BPK255A42	BPK255		AD VINTAGE BELT	x	x	x
BELTS	BPK260A42	BPK260		AD VINTAGE GOLD	x		
BELTS	BPK305A42	BPK305		AD FACET GUNMETAL	x	x	x
BELTS	BPL120A42	BPL120		NEW DIAMOND PATTERN FRAME GOLD	x	x	x
BELTS	BPL145A42	BPL145		NEW FACETED LACQUER PALLADIUM	x	x	x
BELTS	BPL150A42	BPL150		LEATHER INSERT PALLADIUM	x	x	x
BELTS	BPL165A42	BPL165		MICRO D-EIGHT PANEL	x	x	x
BELTS	BPV070A42	BPV070		BELT G/P LEATHER PANELLED REVE		x	
BELTS	BPV080A42	BPV080		BELT PALLADIUM PLATE LEATHER	x		
BELTS	BPZ050A42	BPZ050		BELT SLIDING DOORS PALLADIUM	x	x	x
WATCHES	DUH04201	DUH0420		ATMOS CLOCK S. STEEL PVD AND S	x		
LUGGAGE	FA6060E	FA6060E	SIDECAR	SIDECAR DOUBLE DOCUMENT CASE	x	x	x
LUGGAGE	FA8010E	FA8010E	SIDECAR	SIDECAR SINGLE DOCUMENT CASE	x	x	x
LUGGAGE	FA9000E	FA9000E	SIDECAR	SIDECAR 2 GUSSET POCHEE WITH	x	x	x
SMALL LEATHER	FP1010E	FP1010E	SIDECAR	SIDECAR YEN WALLET 10CC & ZIP	x	x	
SMALL LEATHER	FP1240E	FP1240E	SIDECAR	SIDECAR BILLFOLD 6CC & 2 I.D.	x	x	x
SMALL LEATHER	FP1250E	FP1250E	SIDECAR	SIDECAR BILLFOLD 14CC	x	x	x
SMALL LEATHER	FP3020E	FP3020E	SIDECAR	SIDECAR BILLFOLD 8CC	x	x	x
SMALL LEATHER	FP3070E	FP3070E	SIDECAR	SIDECAR BILLFOLD 4CC & COIN P	x	x	x
SMALL LEATHER	FP4000E	FP4000E	SIDECAR	SIDECAR SIMPLE CARD CASE	x	x	x
SMALL LEATHER	FP4700E	FP4700E	SIDECAR	SIDECAR BUSINESS CARD CASE 2C		x	x
SMALL LEATHER	FP5020E	FP5020E	SIDECAR	SIDECAR 7 HOOK KEYCASE	x	x	x
SMALL LEATHER	FP8000E	FP8000E	SIDECAR	SIDECAR COIN PURSE	x	x	x
SMALL LEATHER	FP9790E	FP9790E	SIDECAR	SIDECAR DOUBLE TRAVEL COMPANIO	x	x	x
BELTS	HPC060A42	HPC060		BELT CLASSIC GUNMETAL 30MM	x	x	x
BELTS	HPD210A42	HPD210		BELT TWIST RECTANGULAR	x	x	x
BELTS	HPF116A42	HPF116		SQUARE ENGINE TURNED RIVET BEL	x	x	x
BELTS	HPF124A42	HPF124		CURVED ENGINE TURNED RIVET BEL	x	x	x
BELTS	HPG130B42	HPG130		LACQUERED RECTANGULAR PALLADIU	x	x	x
BELTS	HPH135B42	HPH135		SPLIT CARBON BROWN	x	x	x
BELTS	HPH160A42	HPH160		CARBON ENGINE RIVET GOLD	x		
BELTS	HPH170A42	HPH170		CURVED ENGINE RIVET + CARBON F	x	x	x
BELTS	HPJ235A42	HPJ235		SQUARE ENGINE RIVET GUNMETAL		x	x
BELTS	HPJ245A42	HPJ245		TWIST PALLADIUM REVERSIBLE		x	x
BELTS	HPJ250A42	HPJ250		TWIST ROUND REVERSIBLE		x	x
BELTS	HPK145A42	HPK145		ROUNDED RECTANGLE CARBON FIBRE	x	x	x
BELTS	HPK210A42	HPK210		SINGLE RING PALLADIUM	x	x	x
BELTS	HPK215A42	HPK215		BRASS BRIDLE BELT			
BELTS	HPK220A42	HPK220		SIMPLE ANTIQUE SILVER BELT	x	x	x
BELTS	HPK235A42	HPK235		DIAMOND PATTERN TONGUE PALLADI	x	x	x
BELTS	HPK275A42	HPK275		TRIMETAL BELT	x	x	x
BELTS	HPK320B42	HPK320		CURVED BRIDLE BELT	x	x	x
BELTS	HPL100A42	HPL100		CLASSIC REVERSIBLE	x	x	x
BELTS	HPL105A42	HPL105		ROUNDED BUCKLE ENGINE TURNED R	x	x	x
BELTS	HPL110A42	HPL110		CARBON FIBRE INSERT GUNMETAL	x	x	x
BELTS	HPL125A42	HPL125		CURVED ENGINE TURNED PALLADIU	x	x	x
BELTS	HPL130A42	HPL130		CURVED ENGINE TURNED ROSE GOL	x	x	x
BELTS	HPL135B42	HPL135		DOUBLE PRONG GUNMETAL	x	x	x
BELTS	HPL140A42	HPL140		PALLADIUM FRAME	x	x	x
BELTS	HPL155A42	HPL155		WINDSOR DUNHILL LACQUER	x	x	x
BELTS	HPL160B42	HPL160		BLADON LEATHER INSERT	x	x	x
BELTS	HPT010A42	HPT010		BELT CLASSIC BUCKLE LOGO REVER	x	x	x
BELTS	HPT020A42	HPT020		BELT CLASSIC GP LOGO BLK REVER	x		
BELTS	HPW100A42	HPW100		BELT REVERS. TWIST SQUARE PALL	x	x	x
BELTS	HPZ190A42	HPZ190		BELT SPOILER PALLADIUM		x	x
CUFFLINKS	JBF6200H	JBF6200	H	CUFFLINKS CLOVER BLACK MOP SS	x		x
CUFFLINKS	JBF6201H	JBF6201	H	CUFFLINKS BULLDOG ONYX SS C MA	x		
CUFFLINKS	JBG6202H	JBG6202	H	CUFFLINKS JADE TURTLE SS C MK	x		
CUFFLINKS	JBG8285H	JBG8285	H	CL SENTRYMAN BLK DIAMONDS SS C	x		
CUFFLINKS	JBH4224H	JBH4224	H	CLINKS FOUR LEAF CLOVER PINK	x		
CUFFLINKS	JBK4274H	JBK4274	H	CLINK LONDON LANTERN DIAMOND P		x	x
OTHER JEWELLERY	JBY8714H	JBY8714	H	BULLDOG PAPER WEIGHT S/S CONVE	x		x
OTHER JEWELLERY	JBZ8609H	JBZ8609	H	MONEYCLIP STEERING WHEEL S/S C	x	x	x
CUFFLINKS	JCE8236H	JCE8236	H	CLINKS F LEAF CLOVER S/S CON M	x	x	x
CUFFLINKS	JCG8244H	JCG8244	H	CUFFLINKS RACING HORSE S/S C M	x	x	x
OTHER JEWELLERY	JCG8844H	JCG8844	H	KEYFOB RACING HORSE S/S CONV M	x	x	x
OTHER JEWELLERY	JDV8803H	JDV8803	H	KEYFOB BULLDOG STERLING SILV	x	x	x
OTHER JEWELLERY	JFE3650K	JFE3650	K				x
OTHER JEWELLERY	JFE8632H	JFE8632	H				x
CUFFLINKS	JFF8218H	JFF8218	H				x
OTHER JEWELLERY	JFG3111K	JFG3111	K	TIEBAR COMPRESSOR PP		x	x
CUFFLINKS	JFG3211K	JFG3211	K	CUFFLINKS COMPRESSOR PP	x	x	x
OTHER JEWELLERY	JFW8607H	JFW8607	H	MONEY CLIP BULLDOG S/S RHDM	x	x	x
CUFFLINKS	JHJ0243K	JHJ0243	K	CLINKS ENGINE TURN LINES PP	x	x	x
CUFFLINKS	JHJ5244K	JHJ5244	K				x
OTHER JEWELLERY	JHK0108K	JHK0108	K	TIEBAR AD FACET PP	x		
OTHER JEWELLERY	JHK0109K	JHK0109	K	TIEBAR AD FACET GP	x		
CUFFLINKS	JHK0206K	JHK0206	K	CLINKS AD FACET PP	x	x	x
CUFFLINKS	JHK0207K	JHK0207	K	CLINKS AD FACET GP	x	x	x
CUFFLINKS	JHL0212K	JHL0212	K	HELM WHEEL CUFFLINKS	x	x	x
OTHER JEWELLERY	JK8700H	JK8700H	H	COLLAR STIFFENERS (PAIR) UK H	x	x	x
CUFFLINKS	JLK0201K	JLK0201	K	CLINKS TORCH PINK	x	x	x
CUFFLINKS	JLK0202K	JLK0202	K	CLINKS TORCH BLUE	x	x	x
CUFFLINKS	JLK0203K	JLK0203	K	CLINKS SUSPENSION COIL	x	x	x
OTHER JEWELLERY	JLK0804K	JLK0804	K	KEYFOB SUSPENSION COIL	x	x	x

PROD CAT	SKU	GENERIC	OTHER INFO	DESCRIPTION	Franchise RP (JS model)	WS RP	APEX WS customers
OTHER JEWELLERY	JLL0124K	JLL0124	K	FACET RUBBER STRIPE TIEBAR	X	X	X
OTHER JEWELLERY	JLL0125K	JLL0125	K	DOUBLE AD COIN TIEBAR	X	X	X
CUFFLINKS	JLL0219K	JLL0219	K	FACET RUBBER STRIPE CUFFLINKS	X	X	X
CUFFLINKS	JLL0220K	JLL0220	K	DOUBLE AD COIN RUBBER CUFFLINK	X	X	X
CUFFLINKS	JLL0221K	JLL0221	K	DECKCHAIR CUFFLINKS	X	X	X
CUFFLINKS	JLL0222K	JLL0222	K	FERRIS WHEEL CUFFLINKS	X	X	X
CUFFLINKS	JLL0223K	JLL0223	K	SENTRYMAN LOGO PVD	X	X	X
CUFFLINKS	JLL0226K	JLL0226	K	SCREW TOP CUFFLINKS	X	X	X
OTHER JEWELLERY	JLL0611K	JLL0611	K	DECKCHAIR MONEYCLIP	X	X	X
OTHER JEWELLERY	JLL0612K	JLL0612	K	FACET RUBBER STRIPE MONEYCLIP	X	X	X
OTHER JEWELLERY	JLL0807K	JLL0807	K	FACET RUBBER STRIPE KEYFOB	X	X	X
OTHER JEWELLERY	JLL0808K	JLL0808	K	DOUBLE AD COIN KEYFOB	X	X	X
CUFFLINKS	JLL8292H	JLL8292	H	FACET PINSTRIPE RED CUFFLINKS	X	X	X
CUFFLINKS	JLL8293H	JLL8293	H	FACET PINSTRIPE BLUE CUFFLINKS	X	X	X
CUFFLINKS	JMD0230K	JMD0230	K	PROVENANCE GTO CUFFLINKS	X		
CUFFLINKS	JMK8202H	JMK8202	H	CUFFLINKS RABBIT S/S C MK	X	X	X
OTHER JEWELLERY	JMK8803H	JMK8803	H	KEYFOB RABBIT S/S C.MK	X	X	X
CUFFLINKS	JML8289H	JML8289	H	CUFFLINKS CRAB S/S C MK	X	X	X
OTHER JEWELLERY	JML8898H	JML8898	H	KEYFOB CRAB S/S C MK	X	X	X
CUFFLINKS	JNG0233K	JNG0233	K	CLINKS ROTATING BUCKLE CARBON	X	X	X
OTHER JEWELLERY	JNG0833K	JNG0833	K	KEYFOB ROTATING BUCKLE CARBON	X	X	X
CUFFLINKS	JNH0240K	JNH0240	K				X
OTHER JEWELLERY	JNL3827K	JNL3827	K	SENTRYMAN SCREW KEYFOB	X	X	X
OTHER JEWELLERY	JPD0812K	JPD0812	K	BULLDOG 2GB USB KEY	X	X	X
OTHER JEWELLERY	JPG0803K	JPG0803	K	CARBON FIBRE 2GB USB KEY	X	X	X
CUFFLINKS	JRG7234K	JRG7234	K	FIGHTER PROVENANCE CUFFLINKS	X		
CUFFLINKS	JSA8206H	JSA8206	H	C/L CLASS BUTT DIAM CON.MK S	X		X
OTHER JEWELLERY	JSB8101H	JSB8101	H	TIEBAR AD COIN ONYX CONV MARK	X	X	X
CUFFLINKS	JSB8201H	JSB8201	H	CUFFLINKS AD COIN ONYX CONV MA	X	X	X
CUFFLINKS	JSB8202H	JSB8202	H	CUFFLINKS AD COIN SODALITE C.M	X	X	X
CUFFLINKS	JSB8203H	JSB8203	H	CUFFLINKS AD COIN WHITE MOP C.	X	X	X
CUFFLINKS	JSD0257K	JSD0257	K	CUFFLINKS SWITCH BLUE MOP	X	X	X
CUFFLINKS	JSD0273K	JSD0273	K	CUFFLINKS AD COIN CARBON FIBRE	X	X	X
OTHER JEWELLERY	JSD3168K	JSD3168		TIEBAR EIGHT PLATINUM PLATED	X		
CUFFLINKS	JSD3268K	JSD3268		CUFFLINKS EIGHT PLATINUM PLATE	X	X	X
CUFFLINKS	JSD8279H	JSD8279		CUFFLINKS TILE DIAMONDS S/S CO	X		
OTHER JEWELLERY	JSE3100K	JSE3100		T/B AD COIN DIAMOND PATTERN RU	X		
CUFFLINKS	JSE3200K	JSE3200		C/L AD COIN D PATTERN RUTHENIU	X	X	X
OTHER JEWELLERY	JSE5103K	JSE5103		TIEBAR AD COIN WHITE MOP GP	X		
CUFFLINKS	JSE5203K	JSE5203		CLINKS AD COIN WHITE MOP GP	X	X	X
CUFFLINKS	JSE8228H	JSE8228	H				X
CUFFLINKS	JSE8276H	JSE8276		CUFFLINKS AD COIN DIAMOND S/S	X		
OTHER JEWELLERY	JSF3102K	JSF3102		TIEBAR FACETED DIAM.PAT. PP	X	X	X
CUFFLINKS	JSF3202K	JSF3202		CUFFLINKS FLYING SCOTSMAN	X		
CUFFLINKS	JSF3203K	JSF3203		CL FACETED DIAM.PAT. PP	X	X	X
CUFFLINKS	JSF8258H	JSF8258		CUFFLINKS JESTER DIAMONDS SS C	X		
CUFFLINKS	JSF8264H	JSF8264		CL STEERING WHEEL WOOD SS C M	X	X	X
CUFFLINKS	JSF8265H	JSF8265		CL STEERING WHEEL DIAMONDS S/S	X		
OTHER JEWELLERY	JSF8804H	JSF8804		KEYFOB STEERING WHEEL WOOD SS	X	X	X
CUFFLINKS	JSG3210K	JSG3210		CUFFLINKS S'MAN CAP BLACK TIE	X		
CUFFLINKS	JSG3213K	JSG3213		CUFFLINKS SPINNING GLOBE PP	X	X	X
CUFFLINKS	JSG3214K	JSG3214		CLINKS SENTRYMAN CAP SODALITE	X	X	X
CUFFLINKS	JSG8205H	JSG8205		CLINKS STUD CARBON FIBRE S/S C	X	X	X
CUFFLINKS	JSH0216K	JSH0216		CLINKS SENTRYMAN CAP ENGINE TU	X	X	X
CUFFLINKS	JSH0245K	JSH0245		CUFFLINKS D BUCKLE PP	X	X	X
CUFFLINKS	JSH0257K	JSH0257	K				X
CUFFLINKS	JSH0258K	JSH0258		CUFFLINKS SWITCH ONYX	X	X	X
CUFFLINKS	JSH8280H	JSH8280		CUFFLINKS TIGER S/S C MK	X	X	X
CUFFLINKS	JSH8290H	JSH8290		CLINKS FACET SQ GALAXY STONE	X	X	X
CUFFLINKS	JSH8291H	JSH8291		CLINKS FACET SQUARE SODALITE	X	X	X
CUFFLINKS	JSH8299H	JSH8299		CLINKS CYLINDER WITH SAPPHIRES	X		
OTHER JEWELLERY	JSH8835H	JSH8835		KEYFOB DECISION COIN S/S C.MK	X	X	X
OTHER JEWELLERY	JSH8881H	JSH8881	H				X
CUFFLINKS	JSJ0202K	JSJ0202		CLINKS HATCH WHEEL RP	X	X	X
CUFFLINKS	JSJ0217K	JSJ0217		CLINKS SENTRYMAN CAP METEORITE	X		X
CUFFLINKS	JSJ8204H	JSJ8204		CLINKS SHARK S/S C MK	X	X	X
CUFFLINKS	JSJ8208H	JSJ8208	H				X
CUFFLINKS	JSJ8292H	JSJ8292		CLINKS FACET SQ ONYX/MOP PINST	X	X	X
CUFFLINKS	JSK8260H	JSK8260		CUFFLINKS SAMURAI SWORD HANDLE	X	X	X
CUFFLINKS	JSK8261H	JSK8261		CUFFLINKS FACET WHITE M. OF PE	X	X	X
OTHER JEWELLERY	JST8701H	JST8701		DRESS STUDS FACET S/S/IL ONYX C	X		
CUFFLINKS	JSV8235H	JSV8235		CLASSIC BUTTON WHITE MOP	X	X	X
OTHER JEWELLERY	JSW8135H	JSW8135		CLASSIC BUTTON TIEBAR WHT M O	X		
CUFFLINKS	JSY8266H	JSY8266		CUFFLINKS STEER'G WHEEL S/S CO	X	X	X
CUFFLINKS	JSY8267H	JSY8267		CUFFLINKS CLASSIC BUTTON S/S M	X	X	X
OTHER JEWELLERY	JTF3101K	JTF3101		TIEBAR HANDLE PP	X		
OTHER JEWELLERY	JTH0619K	JTH0619	K				X
OTHER JEWELLERY	JTJ0128K	JTJ0128		TIEBAR AD VINTAGE LOGO PP	X		
CUFFLINKS	JTJ0227K	JTJ0227		CLINKS AD VINTAGE LOGO PP	X	X	X
OTHER JEWELLERY	JTJ0631K	JTJ0631		MONEYCLIP AD VINTAGE LOGO PP	X	X	X
CUFFLINKS	JTJ0829K	JTJ0829		KEYFOB AD VINTAGE LOGO PP	X	X	X
CUFFLINKS	JTJ8214H	JTJ8214		CLINKS ANCHOR S/S C MK	X	X	X
CUFFLINKS	JTL3210K	JTL3210	K	DOUBLE-SIDED TRAVEL CUFFLINKS	X	X	X
CUFFLINKS	JTL5211K	JTL5211		CLINKS AD VINTAGE LOGO PG	X	X	X
CUFFLINKS	JVT8210H	JVT8210		CUFFLINKS BULLDOG S/SILVER CON	X	X	X
CUFFLINKS	JXJ8230H	JXJ8230		CLINKS SUB WINDOW GALAXY STONE	X	X	X
CUFFLINKS	JXK3200K	JXK3200		CLINKS WING PP	X	X	X
CUFFLINKS	JXK8227H	JXK8227		CLINKS SUB WINDOW HEMATITE S/S	X	X	X
CUFFLINKS	JXK8228H	JXK8228		CLINKS AIRSHIP S/S	X	X	X
SHOES	L1D600B	L1D600		PUNCHED LACE UP	X	X	X
SHOES	L1E317A	L1E317		D EIGHT PVC TRAINER	X		
SHOES	L1F603A	L1F603		FORMAL PUNCHED LACE UP BLACK	X	X	X
SHOES	L1H610A	L1H610		SOFT BLACK LEATHER LACE UP	X		
SHOES	L1J650B	L1J650		NORVEGIAN BROWN LACE UP	X	X	X
SHOES	L1K200A	L1K200		FORMAL LOAFER	X	X	X
SHOES	L1K350A	L1K350		WINDSOR TRAINER	X	X	X
SHOES	L1K600A	L1K600		LACE UP BROGUE	X	X	X
SHOES	L1K600B	L1K600		LACE UP BROGUE	X	X	X
SHOES	L1K605B	L1K605		LACE UP STITCHED VAMP	X	X	X
SHOES	L1L350W	L1L350		NAVY LEATHER TRAINER NAVY SOLE	X	X	X
SHOES	L1L500W	L1L500		NAVY DESERT BOOTS	X		X
SMALL LEATHER	L2F132Z	L2F132	D-EIGHT GREY	D-EIGHT GREY BILLFOLD 4CC & C/	X	X	X

PROD CAT	SKU	GENERIC	OTHER INFO	DESCRIPTION	Franchise RP (JS model)	WS RP	APEX WS customers
SMALL LEATHER	L2F210A	L2F210	SIDECAR GUNMETAL	S GUNMETAL COAT WALLET 10CC W/	x	x	x
SMALL LEATHER	L2F214A	L2F214	SIDECAR GUNMETAL	S GUNMETAL DOUBLE TRAVEL COMPA	x	x	x
SMALL LEATHER	L2F230A	L2F230	SIDECAR GUNMETAL	SIDECAR GUNMETAL BILLFOLD 8CC	x	x	x
SMALL LEATHER	L2F232A	L2F232	SIDECAR GUNMETAL	S GUNMETAL BILLFOLD 4CC & C/PU	x	x	x
SMALL LEATHER	L2G230A	L2G230	ADV8	ADV8 BILLFOLD 8CC	x	x	x
SMALL LEATHER	L2G231A	L2G231	ADV8	ADV8 BILLFOLD 6CC & 2ID	x		
SMALL LEATHER	L2G232A	L2G232	ADV8	ADV8 BILLFLD 4CC & C P	x	x	x
SMALL LEATHER	L2G247A	L2G247	ADV8	ADV8 BUSINESS CARD CASE	x	x	x
SMALL LEATHER	L2G310A	L2G310	MICRO D-EIGHT	MICRO D-EIGHT CT WALLET 10CC W	x	x	x
SMALL LEATHER	L2G314A	L2G314	MICRO D-EIGHT	MICRO D-EIGHT DBL TRAVEL COMP	x	x	x
SMALL LEATHER	L2G330A	L2G330	MICRO D-EIGHT	MICRO D-EIGHT BILLFOLD 8CC	x	x	x
SMALL LEATHER	L2G332A	L2G332	MICRO D-EIGHT	MICRO D-EIGHT BILLFOLD 4CC & C	x	x	x
SMALL LEATHER	L2G347A	L2G347	MICRO D-EIGHT	MICRO D-EIGHT BUSINESS CARD CA	x	x	x
SMALL LEATHER	L2H210A	L2H210	DUNHILL CHASSIS	DNHL CHASSIS CT WLETT 10CC WTH	x	x	x
SMALL LEATHER	L2H230A	L2H230	DUNHILL CHASSIS	DUNHILL CHASSIS BILLFOLD 8CC	x	x	x
SMALL LEATHER	L2H231A	L2H231	DUNHILL CHASSIS	DUNHILL CHASSIS BILLFOLD 6CC &	x	x	x
SMALL LEATHER	L2H232A	L2H232	DUNHILL CHASSIS	DUNHILL CHASSIS BLFLD 4CC & C	x	x	x
SMALL LEATHER	L2H247A	L2H247	DUNHILL CHASSIS	DUNHILL CHASSIS BUSINESS CARD	x	x	x
SMALL LEATHER	L2H250A	L2H250	DUNHILL CHASSIS	DUNHILL CHASSIS 7 HOOK KEYCASE	x	x	x
SMALL LEATHER	L2H714B	L2H714	D-EIGHT BROWN	D-EIGHT BROWN DBLE ZIP TRAVEL	x	x	x
SMALL LEATHER	L2J214A	L2J214	DUNHILL CHASSIS	DUNHILL CHASSIS DBLE ZIP TRVL	x	x	x
SMALL LEATHER	L2JC10A	L2JC10	EXPLORER	EXPLORER COAT WALLET 10CC WITH	x		
SMALL LEATHER	L2JC10B	L2JC10	EXPLORER	EXPLORER COAT WALLET 10CC WITH	x		
SMALL LEATHER	L2JC30A	L2JC30	EXPLORER	EXPLORER BILLFOLD 8CC	x		
SMALL LEATHER	L2JC30B	L2JC30	EXPLORER	EXPLORER BILLFOLD 8CC	x		
SMALL LEATHER	L2JC32A	L2JC32	EXPLORER	EXPLORER BILLFOLD 4CC & COIN P	x		
SMALL LEATHER	L2JC32B	L2JC32	EXPLORER	EXPLORER BILLFOLD 4CC & COIN P	x		
SMALL LEATHER	L2JC47A	L2JC47	EXPLORER	EXPLORER BUSINESS CARD CASE	x		
SMALL LEATHER	L2JC47B	L2JC47	EXPLORER	EXPLORER BUSINESS CARD CASE	x		
SMALL LEATHER	L2K310B	L2K310	MICRO D-EIGHT	MICRO D-EIGHT CT WALLET 10CC W	x	x	x
SMALL LEATHER	L2K330B	L2K330	MICRO D-EIGHT	MICRO D-EIGHT BILLFOLD 8CC	x	x	x
SMALL LEATHER	L2K331B	L2K331	MICRO D-EIGHT	MICRO D-EIGHT BILLFOLD 6CC & 2	x	x	x
SMALL LEATHER	L2K332B	L2K332	MICRO D-EIGHT	MICRO D-EIGHT BILLFOLD 4CC & C	x	x	x
SMALL LEATHER	L2K347B	L2K347	MICRO D-EIGHT	MICRO D-EIGHT BUSINESS CARD CA	x	x	x
SMALL LEATHER	L2K545B	L2K545	ADV8 BROWN	ADV8 BROWN ORGANISER	x	x	x
SMALL LEATHER	L2K710A	L2K710	WINDSOR	WINDSOR COAT WALLET 10CC WITH	x	x	x
SMALL LEATHER	L2K714A	L2K714	WINDSOR	WINDSOR DOUBLE ZIP TRAVEL COMP	x	x	x
SMALL LEATHER	L2K730A	L2K730	WINDSOR	WINDSOR BILLFOLD 8CC	x	x	x
SMALL LEATHER	L2K731A	L2K731	WINDSOR	WINDSOR BILLFOLD 6CC & 2ID	x		
SMALL LEATHER	L2K732A	L2K732	WINDSOR	WINDSOR BILLFOLD 4CC & COIN PU	x	x	x
SMALL LEATHER	L2K747A	L2K747	WINDSOR	WINDSOR BUSINESS CARD CASE	x	x	x
SMALL LEATHER	L2K750A	L2K750	WINDSOR	WINDSOR 7 HOOK KEYCASE	x	x	x
SMALL LEATHER	L2K780A	L2K780	WINDSOR	WINDSOR COIN PURSE	x		
SMALL LEATHER	L2KB45A	L2KB45	ADV8 BLACK	ADV8 BLACK ORGANISER	x	x	x
SMALL LEATHER	L2L210B	L2L210	CORDOVAN	Cordovan Coat Wallet 10CC with Zip			x
SMALL LEATHER	L2L230B	L2L230	CORDOVAN	Cordovan Billfold 8CC			x
SMALL LEATHER	L2L232B	L2L232	CORDOVAN	Cordovan Billfold 4CC & Coin Purse			x
SMALL LEATHER	L2L240B	L2L240	CORDOVAN	Cordovan Simple Card Case			x
SMALL LEATHER	L2L277B	L2L277	CORDOVAN	Cordovan Travel Card Case			x
SMALL LEATHER	L2L510N	L2L510	CHASSIS NAVY	Coat Wallet 10 CC with Zip			x
SMALL LEATHER	L2L530N	L2L530	CHASSIS NAVY	Billfold 8 CC			x
SMALL LEATHER	L2L531N	L2L531	CHASSIS NAVY	Billfold 6CC & 2 ID			x
SMALL LEATHER	L2L532N	L2L532	CHASSIS NAVY	Billfold 4CC & Coin Purse			x
SMALL LEATHER	L2L547N	L2L547	CHASSIS NAVY	Business Card Case			x
SMALL LEATHER	L2L710A	L2L710	YORK	YORK COAT WALLET WITH ZIP	x	x	x
SMALL LEATHER	L2L730A	L2L730	YORK	YORK BILLFOLD 8CC	x	x	x
SMALL LEATHER	L2L731A	L2L731	YORK	YORK BILLFOLD 6CC & 2 ID	x	x	x
SMALL LEATHER	L2L732A	L2L732	YORK	YORK BILLFOLD 4CC AND COIN PU	x	x	x
SMALL LEATHER	L2L747A	L2L747	YORK	YORK BUSINESS CARD CASE	x	x	x
SMALL LEATHER	L2L750A	L2L750	YORK	YORK 7 HOOK KEYCASE	x	x	x
LUGGAGE	L3F240A	L3F240	SIDECAR	SIDECAR GUNMETAL DOUBLE DOC CA	x	x	x
LUGGAGE	L3F280A	L3F280	SIDECAR	SIDECAR GUNMETAL SINGLE DOC CA	x	x	x
LUGGAGE	L3F290A	L3F290	SIDECAR	SIDECAR GUNMETAL POCHETTE WITH	x	x	x
LUGGAGE	L3G241A	L3G241	ADV8	ADV8 DBL ZIP BRIEFCASE	x	x	x
LUGGAGE	L3G260A	L3G260	ADV8	ADV8 NORTH SOUTH BAG	x	x	x
LUGGAGE	L3G265A	L3G265	ADV8	ADV8 MESSENGER BAG	x	x	x
LUGGAGE	L3H141A	L3H141	HEIST TRAVELLER	HEIST TRAVELLER DBL DOC CASE W	x	x	x
LUGGAGE	L3H155A	L3H155	HEIST TRAVELLER	HEIST TRAVELLER SMALL TROLLEY	x		
LUGGAGE	L3H160A	L3H160	HEIST TRAVELLER	HEIST TRAVELLER NORTH SOUTH BA	x	x	x
LUGGAGE	L3H170A	L3H170	HEIST TRAVELLER	HEIST TRAVELLER RUCK SAC	x		
LUGGAGE	L3H322B	L3H322	EXPLORER	EXPLORER GRIP BAG	x		
LUGGAGE	L3J220A	L3J220	DUNHILL CHASSIS	DUNHILL CHASSIS SMALL HOLDALL	x	x	x
LUGGAGE	L3J260A	L3J260	DUNHILL CHASSIS	DUNHILL CHASSIS NORTH SOUTH B	x	x	x
LUGGAGE	L3J265A	L3J265	DUNHILL CHASSIS	DUNHILL CHASSIS MESSENGER BAG	x	x	x
LUGGAGE	L3J281A	L3J281	DUNHILL CHASSIS	DUNHILL CHASSIS SGLE ZIP BRIEF	x	x	x
LUGGAGE	L3J325T	L3J325	BLADON	BLADON 24 HOURS	x	x	x
LUGGAGE	L3J381T	L3J381	BLADON	BLADON SINGLE ZIP BRIEFCASE	x	x	x
LUGGAGE	L3J981A	L3J981	ADV8	ADV8 SINGLE ZIP BRIEFCASE	x		
LUGGAGE	L3K265A	L3K265	HEIST TRAVELLER	HEIST TRAVELLER MESSENGER BAG	x	x	x
LUGGAGE	L3K274A	L3K274	HEIST TRAVELLER	HEIST TRAVELLER TRIFOLD SUIT C	x	x	x
LUGGAGE	L3K496A	L3K496	AVORITIES LEATHER	AVORITIES LEATHER SMALL RUCK S	x		
LUGGAGE	L3K522B	L3K522	ADV8 BROWN	ADV8 GRIP BAG	x	x	x
LUGGAGE	L3K541B	L3K541	ADV8 BROWN	ADV8 DOUBLE ZIP BRIEFCASE	x	x	x
LUGGAGE	L3K560B	L3K560	ADV8 BROWN	ADV8 NORTH SOUTH BAG SMALL	x	x	x
LUGGAGE	L3K565B	L3K565	ADV8 BROWN	ADV8 MESSENGER BAG	x	x	x
LUGGAGE	L3K581B	L3K581	ADV8 BROWN	ADV8 SINGLE ZIP BRIEFCASE	x	x	x
LUGGAGE	L3K725A	L3K725	WINDSOR	WINDSOR 24 HOURS BAG	x	x	x
LUGGAGE	L3K741A	L3K741	WINDSOR	WINDSOR AD DOUBLE ZIP BRIEFCAS	x	x	x
LUGGAGE	L3K760A	L3K760	WINDSOR	WINDSOR NORTH SOUTH BAG WITH F	x	x	x
LUGGAGE	L3K765A	L3K765	WINDSOR	WINDSOR AD MESSENGER BAG WITH	x	x	x
LUGGAGE	L3K791A	L3K791	WINDSOR	WINDSOR POCHETTE WITH ZIP	x		
LUGGAGE	L3K922A	L3K922	BLADON	BLADON 48 HOUR BAG	x	x	x
LUGGAGE	L3K925A	L3K925	BLADON	BLADON 24 HOUR BAG	x	x	x
LUGGAGE	L3K981A	L3K981	BLADON	BLADON SINGLE ZIP BRIEFCASE	x	x	x
LUGGAGE	L3KB25A	L3KB25	ADV8	ADV8 24 HOURS BAG	x	x	x
LUGGAGE	L3L141A	L3L141	AVORITIES 2.0	AVORITIES 2.0 24 HOURS BRIEFC	x	x	x
LUGGAGE	L3L159A	L3L159	AVORITIES 2.0	AVORITIES 2.0 VERTICAL MESSEN	x	x	x
LUGGAGE	L3L160A	L3L160	AVORITIES 2.0	AVORITIES 2.0 NORTH SOUTH BAG	x	x	x
LUGGAGE	L3L181A	L3L181	AVORITIES 2.0	AVORITIES 2.0 SINGLE ZIP BRIE	x	x	x
LUGGAGE	L3L525N	L3L525	CHASSIS NAVY	Vertical Holdall			x
LUGGAGE	L3L541A	L3L541	CHASSIS BLACK	DUNHILL CHASSIS DBLE ZIP BRIEF	x	x	x
LUGGAGE	L3L566N	L3L566	CHASSIS NAVY	Messenger bag with Zip			x

PROD CAT	SKU	GENERIC	OTHER INFO	DESCRIPTION	Franchise RP (JS model)	WS RP	APEX WS customers
LUGGAGE	L3L595N	L3L595	CHASSIS NAVY	Reporter Bag			x
LUGGAGE	L3L640A	L3L640	MICRO D-EIGHT	MICRO D-EIGHT DOUBLE DOCUMENT	x	x	x
LUGGAGE	L3L680A	L3L680	MICRO D-EIGHT	MICRO D-EIGHT SINGLE DOCUMENT	x	x	x
LUGGAGE	L3L690A	L3L690	MICRO D-EIGHT	MICRO D-EIGHT POCHEITTE WITH LO	x	x	x
LUGGAGE	L3L880E	L3L880	BLADON	BLADON DRILL SATCHEL	x	x	x
LUGGAGE	L3L880N	L3L880	BLADON	BLADON DRILL SATCHEL	x	x	x
WRITING INSTRUMENTS	NUA1233	NUA1233		SIDECAR FP BLACK RESIN GP M	X	x	X
WRITING INSTRUMENTS	NUA2203	NUA2203	3				X
WRITING INSTRUMENTS	NUA2233	NUA2233		SIDECAR BP BLACK RESIN GP	X	x	X
WRITING INSTRUMENTS	NUA3203	NUA3203		SIDECAR RB CHASSIS BLACK RESIN	X	x	X
WRITING INSTRUMENTS	NUA3233	NUA3233		SIDECAR RB BLACK RESIN GP	X	x	X
WRITING INSTRUMENTS	NUA4230	NUA4230		SIDECAR PENCIL BLACK RESIN GP	X	x	X
WRITING INSTRUMENTS	NUB2303	NUB2303		SIDECAR REVOLLETTE BLACK LACQUE	X	x	X
WRITING INSTRUMENTS	NUC1423	NUC1423		SIDECAR BROWN ALLIGATOR CHASSI	X		X
WRITING INSTRUMENTS	NUC2423	NUC2423		SIDECAR BP BROWN ALLIGATOR CHA	X		
WRITING INSTRUMENTS	NUD2463	NUD2463	3				X
WRITING INSTRUMENTS	NUD3463	NUD3463		SIDECAR RB CHASSIS BLACK RESIN	X	x	X
WRITING INSTRUMENTS	NUE1633	NUE1633		SIDECAR FP VICTORIAN PDP LACQU	X		
WRITING INSTRUMENTS	NUE2653	NUE2653		SIDECAR REVOLLETTE DIAMOND PATT	X	x	X
WRITING INSTRUMENTS	NUF2783	NUF2783		SIDECAR S'LINER BP BLK LACQUER	X	x	X
WRITING INSTRUMENTS	NUF2793	NUF2793		SIDECAR S'LINER BLK LACQUER GP	X	x	X
WRITING INSTRUMENTS	NUF2823	NUF2823		SIDECAR S'LINER BLK PEARL PDP	X	x	X
WRITING INSTRUMENTS	NUG1783	NUG1783		SIDECAR S'LINER BLACK LACQUER	X	x	X
WRITING INSTRUMENTS	NUG1793	NUG1793	3				X
WRITING INSTRUMENTS	NUG1823	NUG1823	3				X
WRITING INSTRUMENTS	NUG3783	NUG3783		SIDECAR S'LINER RB BLK LACQUER	X	x	X
WRITING INSTRUMENTS	NUG3793	NUG3793		SIDECAR S'LINER RB BLK LACQUER	X	x	X
WRITING INSTRUMENTS	NUG3823	NUG3823		SIDECAR S'LINER RB BLK PEARL P	X	x	X
WRITING INSTRUMENTS	NUH1273	NUH1273	3				X
WRITING INSTRUMENTS	NUH2273	NUH2273		SIDECAR S'LINER BP BLK CHASSIS	X	x	X
WRITING INSTRUMENTS	NUH3273	NUH3273		SIDECAR S'LINER RB BLK CHASSIS	X	x	X
WRITING INSTRUMENTS	NUJ2213	NUJ2213		SIDECAR BP BRIAR WOOD PDP	X	x	X
WRITING INSTRUMENTS	NUJ2253	NUJ2253		SIDECAR REVOLLETTE SKELETON	X		X
WRITING INSTRUMENTS	NUJ2323	NUJ2323		SIDECAR S'LINER BP BRUSHED	X	x	x
WRITING INSTRUMENTS	NUJ3213	NUJ3213		SIDECAR RB BRIAR WOOD PDP	X	x	x
WRITING INSTRUMENTS	NUJ3323	NUJ3323		SIDECAR S'LINER RB BRUSHED	X	x	x
WRITING INSTRUMENTS	NUK2023	NUK2023		SIDECAR LOCOMOTIVE BP	X	x	x
WRITING INSTRUMENTS	NUK3023	NUK3023		SIDECAR LOCOMOTIVE RB	X	x	X
WRITING INSTRUMENTS	NUW1113	NUW1113		SIDECAR FP BLACK RESIN PALLADI	X	x	x
WRITING INSTRUMENTS	NUW2113	NUW2113		SIDECAR BP BLACK RESIN PDP	X	x	x
WRITING INSTRUMENTS	NUW3113	NUW3113		SIDECAR RB BLACK RESIN PDP	X	x	X
WRITING INSTRUMENTS	NUW4110	NUW4110		SIDECAR PENCIL BLACK RESIN PDP	X	x	X
WRITING INSTRUMENTS	NWD1503	NWD1503		SENTRYMAN FP BLACK RESIN PDP	X	x	X
WRITING INSTRUMENTS	NWD1523	NWD1523	3				X
WRITING INSTRUMENTS	NWD1553	NWD1553		SENTRYMAN FP BLACK RESIN GP	X	x	X
WRITING INSTRUMENTS	NWD2503	NWD2503		SENTRYMAN BP BLACK RESIN PDP	X	x	X
WRITING INSTRUMENTS	NWD2513	NWD2513		SENTRYMAN BP DIAMOND PATTERN E	X	x	X
WRITING INSTRUMENTS	NWD2553	NWD2553		SENTRYMAN BP BLACK RESIN GP	X	x	X
WRITING INSTRUMENTS	NWD3503	NWD3503		SENTRYMAN RB BLACK RESIN PDP	X	x	X
WRITING INSTRUMENTS	NWD3513	NWD3513		SENTRYMAN RB DIAMOND PATTERN E	X	x	X
WRITING INSTRUMENTS	NWD3523	NWD3523		SENTRYMAN RB CARBON FIBRE PDP	X	x	X
WRITING INSTRUMENTS	NWD3553	NWD3553		SENTRYMAN RB BLACK RESIN GP	X	x	x
WRITING INSTRUMENTS	NWD4500	NWD4500		SENTRYMAN PENCIL BLACK RESIN P	X	x	x
WRITING INSTRUMENTS	NWD4550	NWD4550		SENTRYMAN PENCIL BLACK RESIN GP	X	x	x
WRITING INSTRUMENTS	NWE1533	NWE1533		SENTRYMAN FP BLK ALLIGATOR PDP	X		X
WRITING INSTRUMENTS	NWE2533	NWE2533		SENTRY BP BLACK ALLIGATOR CHAS	X		
WRITING INSTRUMENTS	NWF1733	NWF1733		SENTRYMAN FP FLYING SCOTSMAN	X		
WRITING INSTRUMENTS	NWF1963	NWF1963		SENTRY FP BLK DIAMONDS C FABRI	X		
WRITING INSTRUMENTS	NWG1353	NWG1353		SENTRYMAN FP BLACK TIE PDP MOP	X		
WRITING INSTRUMENTS	NWG2983	NWG2983	3				X
WRITING INSTRUMENTS	NWG3353	NWG3353		SENTRY RB BLACK TIE PDP MOP	X	x	X
WRITING INSTRUMENTS	NWG3983	NWG3983	3				X
WRITING INSTRUMENTS	NWH1013	NWH1013		SENTRYMAN FP EXPLORER	X		
WRITING INSTRUMENTS	NWH1263	NWH1263		SENTRYMAN FP GREY SHAGREEN PV	X		
WRITING INSTRUMENTS	NWH2523	NWH2523		SENTRYMAN BP CARBON FIBRE PDP	X	x	x
WRITING INSTRUMENTS	NWJ2333	NWJ2333		SENTRYMAN BP METEORITE PVD	X	x	x
WRITING INSTRUMENTS	NWJ2343	NWJ2343		SENTRYMAN BP SOFT LACQUER	X	x	x
WRITING INSTRUMENTS	NWJ3333	NWJ3333		SENTRYMAN RB METEORITE PVD	X	x	x
WRITING INSTRUMENTS	NWJ3343	NWJ3343		SENTRYMAN RB SOFT LACQUER	X	x	x
WRITING INSTRUMENTS	NWK1093	NWK1093		SENTRYMAN EXPLORER II	X	x	x
WRITING INSTRUMENTS	NWK2043	NWK2043		SENTRYMAN USB BLACK PVD	X	x	x
WRITING INSTRUMENTS	NWL2063	NWL2063	3	SENTRYMAN REVOLLETTE	X	x	x
WRITING INSTRUMENTS	NWL2103	NWL2103	3	SENTRYMAN SATIN RUTHENIUM BP	x	x	x
WRITING INSTRUMENTS	NWL3103	NWL3103	3	SENTRYMAN SATIN RUTHENIUM RB	x	x	x
LIGHTERS	PL6200	PL6200		ROLLAGAS 18CT W/GOLD FACET R	X		
LIGHTERS	PL9200	PL9200		MINI ROLLAGAS 18CT FACET ROL	X		
LIGHTERS	PLF6210	PLF6210		HOBNAIL 18CT YELLOW GOLD	X		
LUGGAGE	QB5595	QB5595	AVORITIES LEATHER	AVORITIES LEATHER SML TOURING	x		x
LUGGAGE	QB6020	QB6020	AVORITIES LEATHER	AVORITIES LEATHER NORTH SOUTH	x	x	x
LUGGAGE	QB6040	QB6040	AVORITIES LEATHER	AVORITIES LEATHER SINGLE ZIP D	x	x	x
LUGGAGE	QB6090	QB6090	AVORITIES LEATHER	AVORITIES LEATHER DBLE ZIP D/C	x	x	x
NOVELTIES	QGD0131	QGD0131		POKER SET	X	x	X
NOVELTIES	QGD0321	QGD0321		TRADITION HIP FLASK	X	x	X
NOVELTIES	QGD0323	QGD0323		TRADITION HUNTERS FLASK	X		
NOVELTIES	QGD0325	QGD0325		TRADITION MAHJONG SET	X		
NOVELTIES	QGD0327	QGD0327		TRADITION BACKGAMMON	X		X
NOVELTIES	QGD0331	QGD0331		TRADITION CHESS SET	X		X
NOVELTIES	QGD2001	QGD2001		SIDECAR TUBE UMBRELLA	X		
NOVELTIES	QGD2005	QGD2005		SIDECAR GOLF UMBRELLA	X		
NOVELTIES	QGG1303	QGG1303		GLOBE WITH SENTRYMAN BASE	X		
NOVELTIES	QGH0801	QGH0801		SHAGREEN GAMES COMPENDIUM	X		
NOVELTIES	QGH0803	QGH0803		SHAGREEN CUFFLINK BOX	X		
NOVELTIES	QGH0804	QGH0804		SHAGREEN WATCH BOX	X		
NOVELTIES	QGH2006	QGH2006		TRI-FOLD UMBRELLA WITH CASE	X		
NOVELTIES	QGH8718	QGH8718		STERLING SILVER CHALK HOLDER	X		
NOVELTIES	QGG0805	QGG0805		SHAGREEN SMALL CUFFLINK BOX	X		
NOVELTIES	QGG0806	QGG0806		SHAGREEN RUBIK'S CUBE	X		
NOVELTIES	QGG1023	QGG1023		DESK TOWER GAME	X		X
NOVELTIES	QGG1431	QGG1431		DUNHILL CHASSIS WATCH BOX SMA	X		X
NOVELTIES	QGG1432	QGG1432		DUNHILL CHASSIS WATCH BOX LRG	X		X
NOVELTIES	QGG0169	QGG0169		BIOMETRIC WALLET	X	x	X
NOVELTIES	QGG1027	QGG1027		AD PLAYING CARDS 2 DECKS & CF	X	x	X

PROD CAT	SKU	GENERIC	OTHER INFO	DESCRIPTION	Franchise RP (JS model)	WS RP	APEX WS customers
NOVELTIES	QGK1221	QGK1221		CARBON FIBRE TRAVEL GAME		X	X
NOVELTIES	QGK1429	QGK1429		DUNHILL CHASSIS CUFFLINK BOX	X	X	X
NOVELTIES	QGK1430	QGK1430		DUNHILL CHASSIS CUFFLINK BOX	X	X	X
NOVELTIES	QGK1433	QGK1433		DUNHILL CHASSIS TRAVEL CUFFLIN	X		
NOVELTIES	QGL0175	QGL0175		BEACH TOWEL AND BAG	X	X	X
NOVELTIES	QGL0179	QGL0179		SOLAR CHARGER UNIT AND CASE	X	X	X
NOVELTIES	QGL1482	QGL1482		CHASSIS LEATHER SINGLE PEN CAS	X	X	X
NOVELTIES	QGL1483	QGL1483		CHASSIS LEATHER DOUBLE PEN CAS	X	X	X
NOVELTIES	QGL1484	QGL1484		CHASSIS LEATHER ZIP TOP CASE	X	X	X
NOVELTIES	QGL1485	QGL1485		CHASSIS LEATHER TRAVEL WATCH C	X	X	X
NOVELTIES	QGL1486	QGL1486		CHASSIS LEATHER IPHONE CASE	X	X	X
NOVELTIES	QGL1487	QGL1487		CHASSIS LEATHER BLACKBERRY CAS	X	X	X
LIGHTERS	QL2000	QL2000		UNIQUE TURBO LIGHTER RHODIUM S	X	X	X
LIGHTERS	QLA2603	QLA2603		UNIQUE TURBO BLCK ALLIGATOR RH	X	X	X
LIGHTERS	QLF2001	QLF2001		UNIQUE TURBO LIGHTER DIAMOND	x	X	X
LIGHTERS	QLK2300	QLK2300		SHAGREEN BLACK PVD TURBO LIGH	x	x	X
LIGHTERS	QLL2214	QLL2214		TURBO LIGHTER CARBON FIBRE & R	x	x	X
LIGHTERS	QLL2216	QLL2216		TURBO LIGHTER TEAK WOOD	x	x	x
LIGHTERS	QLV2614	QLV2614		UNIQ.TURBO LIGHTER SIDECAR JA	x	X	X
LIGHTERS	RL1301N	RL1301	N	ROLLAGAS BARLEY ENGINE TURNING	x	x	X
LIGHTERS	RL2401N	RL2401	N	ROLLAGAS LIGHTER G/P BLACK LA	x	x	X
LIGHTERS	RL2491N	RL2491	N	ROLLAGAS G/P PINSTRIPE BLACK	x	x	X
LIGHTERS	RL8400N	RL8400	N	ROLLAGAS LIGHTER G/P SIGNATURE	x	x	X
LIGHTERS	RLD3302	RLD3302		ROLLAGAS CARBON FIBRE PALLADIU	x	x	X
LIGHTERS	RLG2323	RLG2323					X
LIGHTERS	RLG3325	RLG3325		ROLLAGAS BLACK RESIN D PATTERN	x	x	X
LIGHTERS	RLH1375	RLH1375		ROLLAGAS TIGER PATTERN PALLAD	x	x	X
LIGHTERS	RLJ2553	RLJ2553		RGAS SOFT LACQUER RUP	x	x	X
LIGHTERS	RLJ3305	RLJ3305		ROLLAGAS BRIAR WOOD PDP	x	x	X
LIGHTERS	RLK1500	RLK1500		ROLLAGAS GROOVE	x	x	X
LIGHTERS	RLK1504	RLK1504		ROLLAGAS TEXALIUM	x	x	X
LIGHTERS	RLL1313	RLL1313		ROLLAGAS AD VINTAGE LOGO PALLA	x	x	x
LIGHTERS	RLL2510	RLL2510		ROLLAGAS SATIN RUTHENIUM	x	x	X
LIGHTERS	RLZ2311N	RLZ2311	N	ROLLAGAS BLACK LACQUER PDP	x	x	X
LIGHTERS	RLZ3300N	RLZ3300	N	RGAS SIDECAR LEATHER PDUIUM P	x	x	X
SHOES	S21110C	S21110		TUDOR TUBULAR LOAFER DK BROWN	x		
SHOES	S21110L	S21110		TUDOR TUBULAR LOAFER DK BROWN	x	x	x
LIGHTERS	UL1301	UL1301		UNIQUE PIPE LIGHTER S/P F/BARL	x	x	X
LIGHTERS	UL1302	UL1302		UNIQUE LIGHTER S/P FULL LINES	x	X	X